



SWISS MADE
SWISS TECHNOLOGY

SERIES 360
ADVANCED MODELS



PRECISA DNA: ZERO COMPROMISE

Laboratory and industrial technicians are aware of the significance of the results they provide. That is why they are unwilling to accept any compromise in their field of work. This is precisely why leading specialists around the world place their trust in Precisa and have done for decades.

PRECISA DNA: SWISS PRECISION

Precisa products are prime examples of Swiss perfection and reliability. They are tried and tested in both demanding laboratory environments and industrial applications, and are subject to rigorous quality controls throughout the entire manufacturing process. Precisa invests continuously in developing new technologies and employs a highly qualified team. The result is a state-of-the-art range of precision instruments for the most exacting demands.

PRECISA DNA: SERIES 360

Precisa Gravimetrics provide 40 years of knowledge and experience in precision, balance technology and manufacturing. Made in Switzerland.

With the 360 series, Precisa is setting new standards in the demanding area of high-end laboratory balances: innovative, high-tech instrumentation which includes the latest technical developments, unique performance features, best user-interface and the most modern design to establish the 360 series as the very bench-mark for modern laboratory technology.



HIGH PRECISION TECHNOLOGY

The 360 series owes its extremely high reliability and durability to the well-known competence of Precisa's engineering and development and, as a result, exceeds all established industry standards. The weighing cell is of the highest mechanical quality, operates extremely precisely; it can also be repaired easily and economically. In addition, our fully automatic, programmable time and temperature controlled calibration system ensures absolute accuracy. Previous calibration information is stored and can be printed upon demand. Adjustable environmental settings provide superior performance in difficult production environments or unstable laboratory conditions.

EXPANDED WEIGHING RANGE

Precisa balances distinguish themselves through their high weighing ranges, as yet unsurpassed in the market. Milligram resolution balances with weighing ranges of over two kilograms, or balances with a weighing range of eight kilograms and a readability of one hundredth of a gram.

HIGH PRECISION TECHNOLOGY

Bright, high-contrast liquid crystal display with backlight, structured access to the menu with short text prompts offer an outstanding operating simplicity.

IMPRESSIVE DESIGN

The modern, slim design by designer Paolo Fancelli gives our compact, integrated technology an impressive form and positions the new series visually in a class of its own.

INTUITIVE USER-INTERFACE

The structured access to the menu and the clearly presented, easy to read display offers simplicity of operation which until now has simply not been available. A few examples of the versatile control offered by the 360 series include the start-up display which can be personalised, freely selectable display options and softkeys for direct menu navigation. Furthermore, additional information can be zoomed onto the main display and the useful Language Tool makes it easy for the user to load his or her own language and characters onto the balance display.

FEATURES

PRECISA SERIES 360 EP

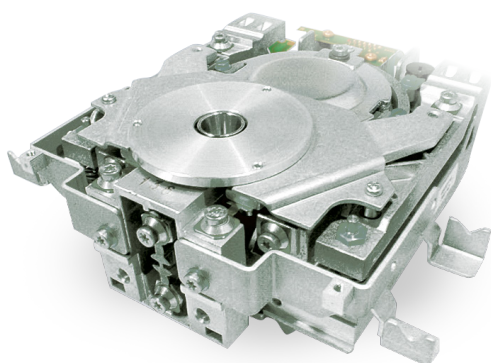

Pure Swiss Precision at the Heart of the Balance

Highly Precise Technology

The 360 series owes its extremely high reliability and durability to the well-known competence of Precisa's engineering and development and, as a result, exceeds all established industry standards. The electromagnetic force compensation weighing cell is of the highest mechanical quality, and operates extremely precisely; it can also be repaired easily and economically. Moreover, our fully automatic, programmable time and temperature controlled calibration system ensures absolute accuracy.

Highest Degree of Functionality

A wide variety of specific applications is easily selectable and guarantees the highest degree of functionality. The freely programmable storage area offers the option to download additional, user-specific applications via the internet. As a result, the 360 series provides an extremely broad spectrum of applications.

Versatile Connectivity

Precisa's new, advanced insert technologies, featuring the slide-in module, provide a range of connection options which until now have not been available. The interchangeable inserts assure connection to future communication technologies.

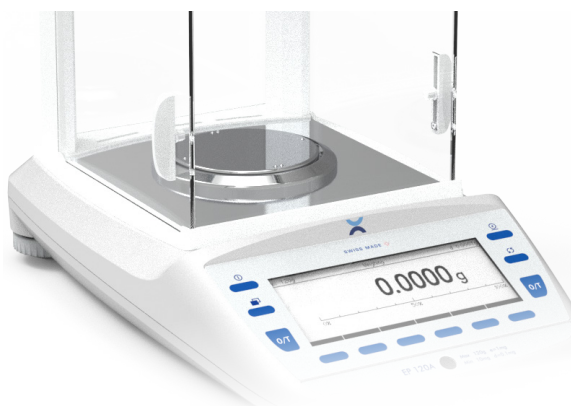

High Degree of Functionality and Applications

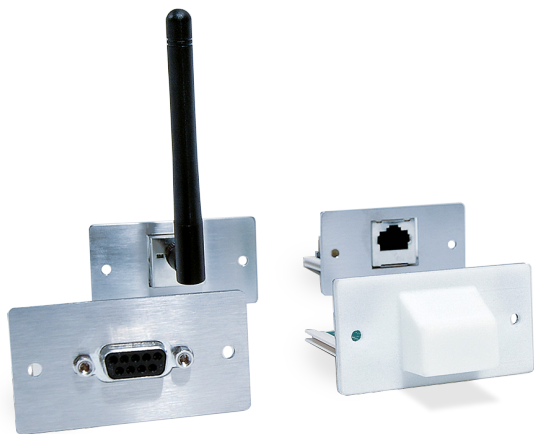

Advanced, Versatile Connectivity

FEATURES

PRECISA SERIES 360 ES



Ambidextrous Draft Shield for Optimum Conditions

Innovative Draft Shield

The ambidextrous draft shield provides optimum conditions for fast high-precision measurements at a resolution of 0.01 mg and 0.1mg and is extremely easy to clean.

Advanced Functionality

A wide variety of specific applications is easily selectable and guarantees the highest degree of functionality. As a result, the 360 series provides an extremely broad spectrum of applications for almost any lab weighing demand.

Among others are minimum weight application, advanced pipette calibration, buoyancy correction and many more.

Multi-purpose Connectivity

Standard USB and RS232 interfaces for fast and convenient connection to a desktop computer and printer.



Advanced Functionality for a Wide Range of Applications



Advanced, Multi-purpose Connectivity

MODELS

EP MODEL

Model	Capacity	Readability	Repeatability (Load >5%)	Min. Weight (1%, k=2, Load >5%)	Linearity	Pan Size (mm)	Class / „e“	Response Time	Item No.
-------	----------	-------------	--------------------------	---------------------------------	-----------	---------------	-------------	---------------	----------

Semi-Micro Balances

EP 125SM	125 g	0.01 mg	0.02 mg	4.0 mg*	0.03 mg	ø 80	I / 1 mg**	8 s	360-9100-006
EP 225SM-DR	102 g / 225 g	0.01 mg / 0.1 mg	0.02 mg	4.0 mg*	0.03 mg / 0.1 mg	ø 80	I / 1 mg**	8 s / 3 s	360-9101-006

Analytical Balances

EP 120A	120 g	0.1 mg	0.1 mg	20 mg*	0.2 mg	ø 90	I / 1 mg**	2 s	360-9231-006
EP 220A	220 g	0.1 mg	0.1 mg	20 mg*	0.2 mg	ø 90	I / 1 mg**	2 s	360-9232-006
EP 320A	320 g	0.1 mg	0.1 mg	20 mg*	0.2 mg	ø 90	I / 1 mg**	3 s	360-9233-006
EP 420A	420 g	0.1 mg	0.15 mg	30 mg*	0.4 mg	ø 90	I / 1 mg**	3 s	360-9234-006
EP 520A	520 g	0.1 mg	0.15 mg	30 mg*	0.4 mg	ø 90	–	4 s	360-9236-006
EP 420A-FR	120 g - 420 g	0.1 mg / 1 mg	0.15 mg / 1 mg	30 mg*	0.3 / 1 mg	ø 90	I / 1 mg**	3 s	360-9235-006

Model	Capacity	Readability	Repeatability	Linearity	Pan Size (mm)	Class / „e“	Response Time	Item No.
-------	----------	-------------	---------------	-----------	---------------	-------------	---------------	----------

Precision Balances

EP 320M	320 g	1 mg	1 mg	1.5 mg	135 x 135	II / 10 mg**	1.5 s	360-9345-001
EP 620M	620 g	1 mg	1 mg	1.5 mg	135 x 135	II / 10 mg**	1.5 s	360-9346-001
EP 920M	920 g	1 mg	1 mg	1.5 mg	135 x 135	I / 10 mg**	2 s	360-9347-001
EP 1220M	1 220 g	1 mg	1 mg	2 mg	135 x 135	I / 10 mg**	2 s	360-9348-001
EP 2200M	2 220 g	1 mg	1 mg	2 mg	135 x 135	I / 10 mg**	3 s	360-9351-001
EP 620M-FR	120 g - 620 g	1 mg / 10 mg	1 mg / 10 mg	1.5 mg / 10 mg	135 x 135	II / 10 mg**	1.5 s	360-9349-001
EP 1220M-FR	240 g - 1 220 g	1 mg / 10 mg	1 mg / 10 mg	1.5 mg / 10 mg	135 x 135	I / 10 mg**	2 s	360-9350-001
EP 1200C	1 200 g	0.01 g	0.01 g	10 mg	200 x 200	II / 1 mg**	1.5 s	360-9437-001
EP 2200C	2 200 g	0.01 g	0.01 g	15 mg	200 x 200	II / 1 mg**	1.5 s	360-9438-001
EP 4200C	4 200 g	0.01 g	0.01 g	15 mg	200 x 200	II / 1 mg**	1.5 s	360-9439-001
EP 6200C	6 200 g	0.01 g	0.01 g	15 mg	200 x 200	II / 1 mg**	1.5 s	360-9440-001
EP 8200C	8 200 g	0.01 g	0.01 g	15 mg	200 x 200	II / 1 mg**	1.5 s	360-9441-001
EP 6200C-FR	2 200 g - 6 200 g	0.01 g / 0.1 g	0.01 g / 0.02 g	15 mg / 0.02 g	200 x 200	II / 1 mg**	1.5 s	360-9442-001
EP 8200C-DR	3 200 g / 8 200 g	0.01 g / 0.1 g	0.01 g / 0.03 g	15 mg / 0.05 g	200 x 200	II / 1 mg**	1.5 s	360-9443-001
EP 6200D	6 200 g	0.1 g	0.05 g	0.1 g	200 x 200	II / 1 g**	1 s	360-9534-001
EP 8200D	8 200 g	0.1 g	0.1 g	0.15 g	200 x 200	II / 1 g**	1 s	360-9535-001
EP 12200D	12 200 g	0.1 g	0.1 g	0.15 g	200 x 200	II / 1 g**	2 s	360-9536-001
EP 12200G	12 200 g	1 g	0.5 g	0.5 g	200 x 200	II / 1 g**	1.5 s	360-9613-001

* USP Min. weight (0.1%, k=2, Load >5%) = Min. weight x 10

** EU/OIML type approval on demand

MODELS

ES MODEL

Model	Capacity	Readability	Repeatability (Load >5%)	Min. Weight (1%, k=2, Load >5%)	Linearity	Pan Size (mm)	Class / „e“	Response Time	Item No.
-------	----------	-------------	-----------------------------	---------------------------------------	-----------	---------------	-------------	---------------	----------

Semi-Micro Balances

ES 125SM	125 g	0.01 mg	0.02 mg	4.0 mg*	0.03 mg	ø 80	I / 1 mg**	8 s	360-9102-006
ES 225SM-DR	102 g / 225 g	0.01 mg / 0.1 mg	0.02 mg	4.0 mg*	0.03 mg / 0.1 mg	ø 80	I / 1 mg**	8 s / 3 s	360-9103-006

Analytical Balances

ES 120A	120 g	0.1 mg	0.1 mg	20 mg*	0.2 mg	ø 90	I / 1 mg**	2 s	360-9237-006
ES 220A	220 g	0.1 mg	0.1 mg	20 mg*	0.2 mg	ø 90	I / 1 mg**	2 s	360-9238-006
ES 320A	320 g	0.1 mg	0.1 mg	20 mg*	0.2 mg	ø 90	I / 1 mg**	3 s	360-9239-006
ES 420A	420 g	0.1 mg	0.15 mg	30 mg*	0.4 mg	ø 90	I / 1 mg**	3 s	360-9240-006
ES 520A	520 g	0.1 mg	0.15 mg	30 mg*	0.4 mg	ø 90	–	4 s	360-9242-006
ES 420A-FR	120 g - 420 g	0.1 mg / 1 mg	0.15 mg / 1 mg	30 mg*	0.3 / 1 mg	ø 90	I / 1 mg**	3 s	360-9241-006

Model	Capacity	Readability	Repeatability	Linearity	Pan Size (mm)	Class / „e“	Response Time	Item No.
-------	----------	-------------	---------------	-----------	---------------	-------------	---------------	----------

Precision Balances

ES 320M	320 g	1 mg	1 mg	1.5 mg	135 x 135	II / 10 mg**	1.5 s	360-9352-001
ES 620M	620 g	1 mg	1 mg	1.5 mg	135 x 135	II / 10 mg**	1.5 s	360-9353-001
ES 920M	920 g	1 mg	1 mg	1.5 mg	135 x 135	I / 10 mg**	2 s	360-9354-001
ES 1220M	1 220 g	1 mg	1 mg	2 mg	135 x 135	I / 10 mg**	2 s	360-9355-001
ES 2200M	2 220 g	1 mg	1 mg	2 mg	135 x 135	I / 10 mg**	3 s	360-9358-001
ES 620M-FR	120 g - 620 g	1 mg / 10 mg	1 mg / 10 mg	1.5 mg / 10 mg	135 x 135	II / 10 mg**	1.5 s	360-9356-001
ES 1220M-FR	240 g - 1 220 g	1 mg / 10 mg	1 mg / 10 mg	1.5 mg / 10 mg	135 x 135	I / 10 mg**	2 s	360-9357-001
ES 1200C	1 200 g	0.01 g	0.01 g	10 mg	200 x 200	II / 1 mg**	1.5 s	360-9444-001
ES 2200C	2 200 g	0.01 g	0.01 g	15 mg	200 x 200	II / 1 mg**	1.5 s	360-9445-001
ES 4200C	4 200 g	0.01 g	0.01 g	15 mg	200 x 200	II / 1 mg**	1.5 s	360-9446-001
ES 6200C	6 200 g	0.01 g	0.01 g	15 mg	200 x 200	II / 1 mg**	1.5 s	360-9447-001
ES 8200C	8 200 g	0.01 g	0.01 g	15 mg	200 x 200	II / 1 mg**	1.5 s	360-9448-001
ES 6200C-FR	2 200 g - 6 200 g	0.01 g / 0.1 g	0.01 g / 0.02 g	15 mg / 0.02 g	200 x 200	II / 1 mg**	1.5 s	360-9449-001
ES 8200C-DR	3 200 g / 8 200 g	0.01 g / 0.1 g	0.01 g / 0.03 g	15 mg / 0.05 g	200 x 200	II / 1 mg**	1.5 s	360-9450-001
ES 6200D	6 200 g	0.1 g	0.05 g	0.1 g	200 x 200	II / 1 g**	1 s	360-9537-001
ES 8200D	8 200 g	0.1 g	0.1 g	0.15 g	200 x 200	II / 1 g**	1 s	360-9538-001
ES 12200D	12 200 g	0.1 g	0.1 g	0.15 g	200 x 200	II / 1 g**	2 s	360-9539-001
ES 12200G	12 200 g	1 g	0.5 g	0.5 g	200 x 200	II / 1 g**	1.5 s	360-9614-001

* USP Min. weight (0.1%, k=2, Load >5%) = Min. weight x 10

** EU/OIML type approval on demand

OPTIONS AND ACCESSORIES

Options	360 EP	360 ES
EU-Verification according to 2014/31/EU by Precisa (initial verification), available only for balances with EU/OIML type approval	on demand	on demand
Protection IP65: protection against ingress of dust and low pressure water jets, fitted at factory, not all types available	350-8694	350-8694

Accessories	360 EP	360 ES
Draft shield 321 LG, only for 0.1mg balances, needs weighing pan 321-8006	on demand	on demand
Draft shield 321 LG-M and Draft shield 321 LG-M short	on demand	on demand
Draft shield mg, glass with cover	320-8504	320-8504
Hook for weighing below the balance	350-8527	350-8527
Animal weighing bowl complete for 0.01g, 0.1g and 1g balances	350-8551	350-8551
VasoFrame for 0.01mg and 0.1mg balances with draft shield EP/ES	350-8727	350-8727
Density kit for 0.01 mg and 0.1 mg balances, container size: \varnothing 75 mm, h = 100 mm	350-8636	350-8636
Density kit solids only (without glass body and hook) for 0.01 mg and 0.1 mg balances, container size \varnothing = 75 mm, h = 100 mm	350-8637	350-8637
Glass body for density determination of liquids, $V = 10\text{cm}^3$	350-7054	350-7054
Downholder for samples with $\rho < 1\text{g/cm}^3$	350-7194	350-7194
Protective cover 360 for the whole balance (0.01mg, 0.1mg), set of 5 pieces	350-8676	350-8676
Protective cover 360 for the whole balance (0.01g, 0.1g, 1g), set of 5 pieces	350-8663	350-8663

Slide-in Modules, on demand only	360 EP	360 ES
PrecisaBUS converter, enables connection to almost all PrecisaBUS accessories	–	350-8664
USB Host	350-8665	–
LAN Ethernet connection	350-8666	–
WiFi connection	350-8667	–
Bluetooth connection	350-8668	–
PS 2 female & RS232 DB9 female	350-8670	–

Operating Temperature	Line Voltage, Tolerance	Power Consumption	Frequency
5 .. 40 °C (41 °F .. 104 °F)	115V / 230V, +15% / -20%	18 VA	50 - 60 Hz

SPECIAL PRODUCTS ACCESSORIES





































Common Accessories	360 EP	360 ES
Printer LP4024, 230V / 115V	350-8391	350-8391
Bluetooth connection for Printer LP4024	350-8391-002	350-8391-002
Paper roll for Printer LP4024, set of 4 pieces	350-8392	350-8392
Adhesive paper roll for Printer LP4024, set of 5 pieces	350-8396	350-8396
Ribbon for Printer LP4024	PN 3953-013	PN 3953-013
Paper roll for Printer CBM910	350-8366	350-8366
Ribbon for Printer CBM910	350-8367	350-8367
Multiplexor for up to 7 instruments for serial (RS232) data transmission to PC or Printer (at least one instrument must be a series 320, 321, 330, 335, 365 or 490)	350-8513	350-8513
Data cable DB9m-RJ45, 1.5m, for balance used as reference balance	350-8661	350-8661
Data cable DB9m-DB9f, 1.5m, (PC/Printer LP 4024, 1:1)	350-8672	350-8672
Data cable DB9m-DB25m, 1.5m, (Printer CBM910)	350-8673	350-8673
USB cable A-B, 1.5m, (PC)	PN 3950-125	PN 3950-125
Interface box, Interface and power splitter	350-8940-000	350-8940-000
Interface box, LAN Ethernet connection	on demand	350-8940-001
Interface box, WiFi connection	on demand	350-8940-002
Interface box, Bluetooth connection	on demand	350-8940-003
HID cable, RS232, DB9m-USB-A, 1.5m, (PC), (x: 0=e, 1=d, 2=f)	350-8816-x00	350-8816-x00
External USV accu power pack for continuous operation	350-8662	350-8662
Power splitter cable	350-8399	350-8399
Anti-theft device, mechanical	350-8555	350-8555
Carat bowl (for diamond weighing)	350-8322	350-8322

PrecisaBUS Accessories (available on demand only)	360 EP	360 ES
Remote display free-standing, incl. 1.5 m cable	-	350-8504*
Remote display with wall bracket, incl. 1.5 m cable	-	350-8516*
RS232 interface box for data transmission, DB25f: - to PC, Printer or Barcode-Printer - from Barcode-Reader (350-8856) or reference balance	-	350-8506*
Interface 20mA current loop passive	-	350-8526*
LAN Ethernet connection	-	350-8573*
WiFi connection	-	350-8588*
Signal Lamp, indicator with 3 lamps, green / red / yellow	350-8734	350-8510*
Horn for signal lamp	350-8533	350-8533*
Input / Output module with 6 TTL inputs / 8 relay outputs	on demand	350-8509*
CCE barcode scanner BCS5040, DB25m, with push button, to be connected to Interface RS232 350-8506	-	350-8856

SmartBox® Applications	360 EP	360 ES
SmartBox® Counting	-	350-8511-011*
SmartBox® FPV0 (Finished Goods Packing Control)	-	350-8511-012*
CCE barcode scanner BCS5040, RJ45, with push button to be connected to the SmartBox®	-	350-8531

* Needs PrecisaBUS converter slide-in module 350-8664

FEATURES & APPLICATIONS

Features	EP	ES	Applications	EP	ES
 Swiss Made	✓	✓	 Units g, mg, ozt, lb, tael, etc.	✓	✓
 Backlit Graphic LCD	✓		 Percent weighing	✓	✓
 Backlit LCD		✓	 Piece counting	✓	✓
 Self Calibration System	✓	✓	 Animal weighing	✓	✓
 Clock (printout GLP/GMP, auto-cal etc.)	✓	✓	 Dynamic difference weighing	✓	✓
 Below balance weighing	✓	✓	 Free conversion Area Conversion	✓	✓
 Anti-theft protection with password plus mechanical security	✓	✓	 Statistics	✓	✓
 Easy alphanumeric input	✓		 Recorder	✓	✓
 Direct tare and reference weigh entry (manually)	✓		 Minimum sample weight	✓	✓
 Identifier and label handling	✓		 Automatic repeatability test	✓	✓
 RS232 interface for PC / printer	✓	✓	 Net total application: Add up summation (Dosing program)	✓	✓
 USB host (barcode, flash drive, ...)	AC		 Checkweighing	✓	✓
 USB device (for PC)	✓	✓	 Density determination	✓	✓
 Human Interface Device (for PC)	OD	AC	 Buoyancy error suppression technology	✓	✓
 LAN Ethernet connection	AC	AC	 Multilevel back weighing	✓	✓
 WiFi connection	AC	AC	 Pipette calibration, optionally with evaporation trapweighing	✓	✓
 Bluetooth connection	AC	AC			
 Precisa BUS		OD			
 External I/O (tare, print, ..., relay)	OD	OD			
 EU/OIML type approval	✓	✓			
 Support IQ/OQ/PQ	✓	✓			

DIMENSIONS

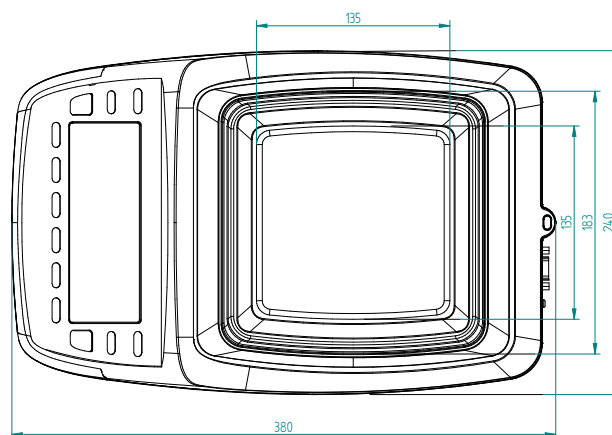
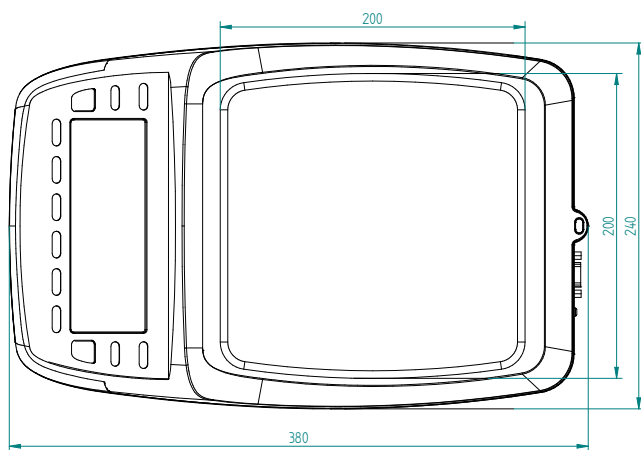
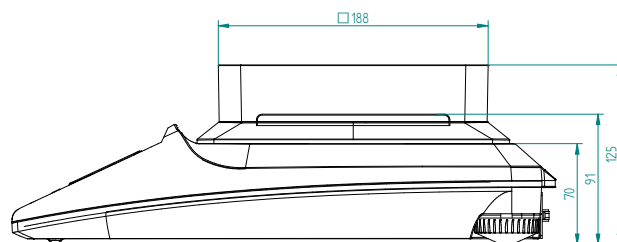
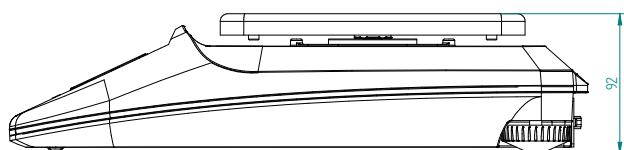
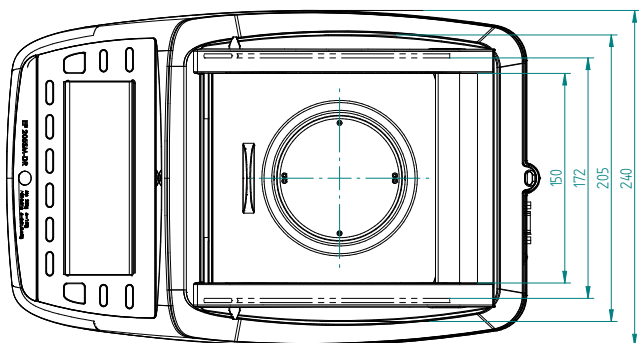
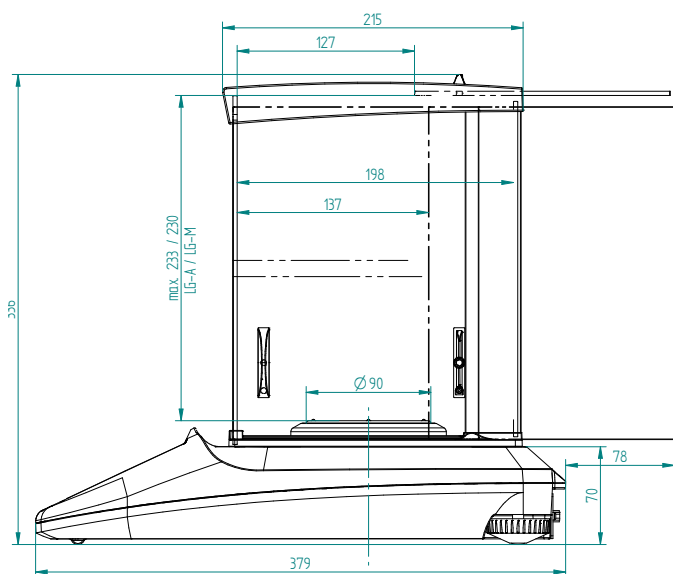

TECHCOMP GROUP

In addition to Precisa, Techcomp Europe comprises of the following companies:

