

**Moisture analyser
XM 60, XM 60-HR,
XM 66**

Operating Instructions



Konformitätserklärung

Declaration of conformity for apparatus with CE mark
Konformitätserklärung für Geräte mit CE-Zeichen
Déclaration de conformité pour appareils portant la marque CE
Declaración de conformidad para aparatos con disitintivo CE
Dichiarazione di cofnromità per apparecchi contrassegnati con la marcatura CE

English	We hereby declare that the product to which this declaration refers conforms with the following standards.
Deutsch	Wir erklären hiermit, dass das Produkt, auf das sich diese Erklärung bezieht, mit den nachstehenden Normen übereinstimmt.
Français	Nous déclarons avec cela responsabilité que le produit, auquel se rapporte la présente déclaration, est conforme aux normes citées ci-après.
Español	Manifestamos en la presente que el producto al que se refiere esta declaración est''a de acuerdo con las normas siguientes
Italiano	Dichiariamo con ciò che il prodotto al quale la presente dichiarazione si riferisce è conforme alle norme di seguito citate.

Moisture Balance: Precisa XM 10 SE
Precisa XM 50
Precisa XM 60, XM 60-HR
Precisa XM 66
Precisa XM 120M, XM 120M-HR
Precisa EM 120-HR

with infrared radiator, halogen radiator or dark radiator

Mark applied	EU Directive	Standards
	2004/108/EC 2006/95/EC	EN 61326 EN 61010

Date: 04.10.2011

Signature:



R. Grolimund R & D Manager

Precisa Gravimetrics AG , Moosmattstrasse 32 , Postfach 352 , CH-8953 Dietikon

350-7579-004

Identification

These Operating Instructions apply to the Precisa XM series moisture analyser with its ten-key control panel and multifunction display.

Customer Service

Precisa Gravimetrics AG
Moosmattstrasse 32
CH-8953 Dietikon
Tel. + 41-44-744 28 28
Fax. + 41-44-744 28 38
email service@precisa.ch

For information on local customer service centers:
<http://www.precisa.com>

Copyright

These Operating Instructions are protected by copyright. All rights reserved. No part of the Operating Instructions may be reproduced, processed, duplicated or published in any form by photocopying, microfilming, reprinting or other process, in particular electronic means, without the written agreement of Precisa Gravimetrics AG.

© Precisa Gravimetrics AG, 8953 Dietikon, Switzerland, 2011.

■ Overview

Overview

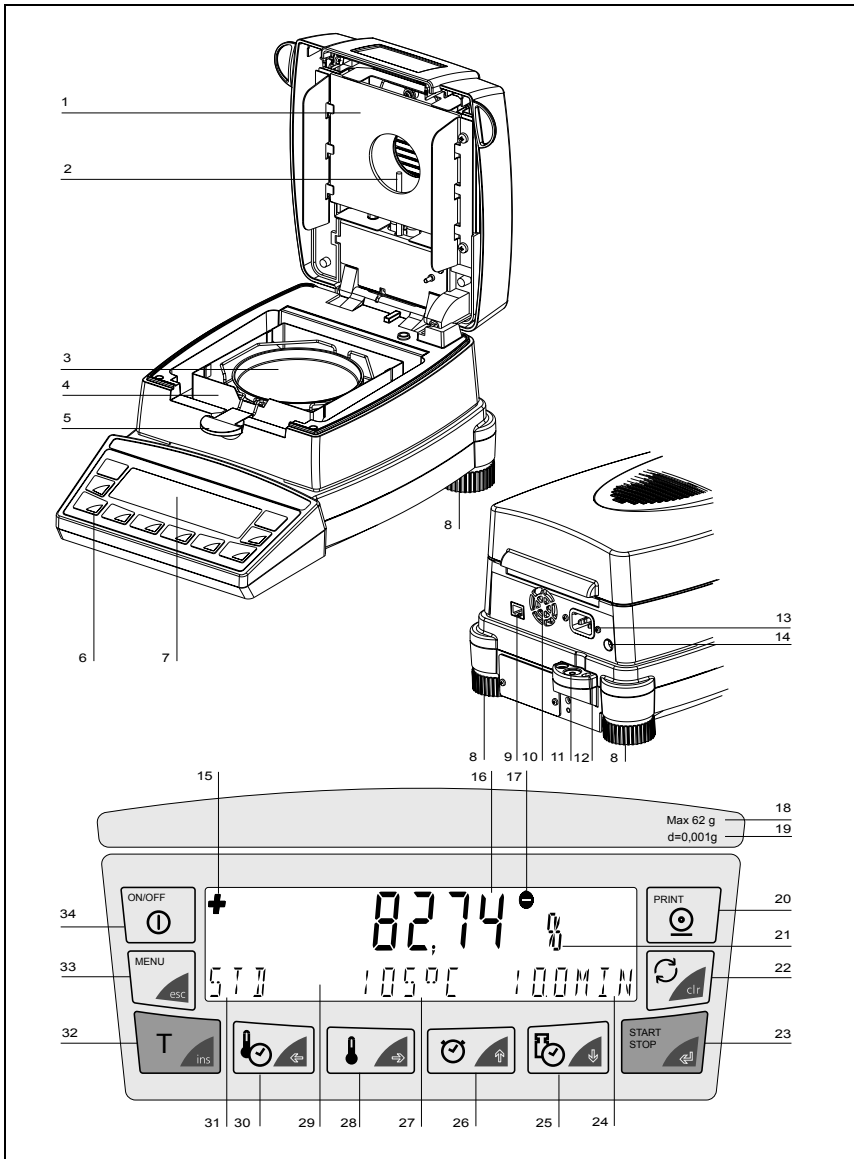

No.	Description	Section
1	Halogen heater	5.1
2	PT100 temperature sensor	8.3.2
3	Weighing pan	3.3 / 5.2
4	Draftshield	3.3
5	Sample holder	3.3
6	10-key membrane keypad	4.1
7	Display	3.9
8	Rotating adjustable feet	3.7
9	Serial interface, RJ45 socket	7.1
10	Fan	3.9
11	Levelling bubble	3.7
12	Mechanical anti-theft protection	
13	Mains connection socket	3.5
14	Mains fuse	8.2
15	Prefix display	4.4.4 / 4.4.6
16	Measurement display	3.9
17	Starting weight	4.4.3
18	Weighing range	9.1
19	Readability	9.1
20	Print key	4.5.2
21	Unit display	4.4.4
22	Change key	4.5.3
23	Start / Stop key	4.5.4 / 5.2.1
24	Drying time display	3.9
25	Stop mode key	5.3.4
26	Time key	5.3.3
27	Temperature display	3.9
28	Temperature key	5.3.2
29	Info line	3.9
30	Heat mode key	5.3.1
31	Heat mode display	3.9
32	Tare key	4.5.1
33	Menu key	4.3.1 / 4.4.1
34	ON / OFF key	3.9

■ *Table of Contents*

	Identification	1
	Overview	2
1	Introduction	7
1.1	Useful tips on the Operating Instructions	8
1.2	Warranty card	8
2	Safety	9
2.1	Representations and symbols	9
2.2	Safety instructions	9
3	Set up	11
3.1	Unpacking	11
3.2	Transport, storage	12
3.2.1	Transport and shipping	12
3.2.2	Storage	12
3.3	Inspection and assembly	13
3.4	Choosing a suitable location	14
3.5	Connecting it to the mains	15
3.6	Safety measures	16
3.7	Levelling	16
3.8	Weight calibration	17
3.9	First measurement	18
4	Operation	21
4.1	Menu control operation principle	21
4.2	Setting and saving the configuration	22
4.3	Instrument configuration	23
4.3.1	Activating the configuration menu	24
4.3.2	Language function	24
4.3.3	Configuring the report printout	24
4.3.4	Configuring the application menu	27
4.3.5	Configuring the ash residue program	27
4.3.6	Balance calibration	28
4.3.7	Temperature calibration	28

4.3.8	Stability	28
4.3.9	Quick-start	28
4.3.10	Interface functions	29
4.3.11	Date and time	29
4.3.12	Password protection	30
4.3.13	Anti-theft encoding.....	32
4.3.14	Key tone	33
4.3.15	Contrast.....	33
4.4	Application menu operation	34
4.4.1	Activating the application menu	34
4.4.2	Methods	35
	Saving a method	36
	Loading a method.....	37
	Deleting a method	37
	Setting method name.....	38
4.4.3	Starting weight	38
4.4.4	Units	39
4.4.5	Print rate	40
4.4.6	Standby temperature	40
4.4.7	Autostart	41
4.5	Special operating keys	41
4.5.1	The tare key	41
4.5.2	The print key	42
4.5.3	The change key	45
4.5.4	The start/stop key	45
5	Determining moisture levels	46
5.1	Fundamental principles.....	46
5.1.1	Adjusting to the existing measuring process	47
5.2	Sample preparation.....	47
5.2.1	Preventing samples being encrusted	48
5.3	Setting drying parameters.....	49
5.3.1	Heating program	49
5.3.2	Temperature	52
5.3.3	Timer stop.....	52
5.3.4	Switch-off criteria	53
5.4	Statistics (XM 60, XM 60-HR)	55

■ *Table of Contents*

5.4.1	Print statistics	55
5.4.2	Reset statistics.....	56
6	Ash residue program	57
6.1	Ash residue XM 60, XM 60-HR	58
6.2	Ash residue XM 66	59
6.2.1	Ash residue of the desiccated samples	60
6.2.2	Ash residue with new tare weight	62
7	Data transfer	64
7.1	Connection scheme	65
7.2	Remote control commands	66
7.2.1	Examples of the remote control of the instrument.....	67
8	Service	68
8.1	Maintenance and servicing	68
8.2	Replacing the mains fuse	69
8.3	Calibration	70
8.3.1	Calibrating the balance	70
8.3.2	Calibrating the temperature.....	72
8.4	Software update.....	75
8.5	Error messages.....	76
8.5.1	Notes on correcting faults.....	76
9	Overview	78
9.1	Technical data.....	78
9.2	Accessories	80
9.3	Menu	81
9.3.1	Configuration menu tree	81
9.3.2	Application menu tree	83
9.3.3	Key menus	84
9.3.4	Setting drying parameters.....	85
9.3.5	Setting and saving the configuration	86
9.4	Index	87

1 Introduction

The moisture analyser is simple and functional to operate. It is used as a quick and reliable means of determining the moisture content in powders and liquids by the thermogravimetric principle.

The key features of the moisture analyser:

- high-end balance technology built to the highest international standard
- optimum resolution
- easy-to-read vacuum fluorescent display
- large viewing window for perfect sample monitoring
- a memory for 20 methods (XM 60, XM 60-HR), with all the drying settings
- automatic detection that the measurement has ended by means of ADAPTSTOP
- password protection to prevent unauthorized changes to the instrument configuration and drying parameters
- anti-theft code
- printout in line with GLP guidelines (Good Laboratory Practice)
- software update via the Internet
- High resolution moisture version XM 60-HR with ten times higher readability for the weight and ten times higher readability for some of the units for the moisture calculation. For details please refer to (see chapter 4.4.4 "Units").



■ 1 Introduction

1.1 Useful tips on the Operating Instructions

Take the time to read these Operating Instructions from start to finish so that you can make full use of the many benefits and possibilities of the device in your day-to-day work.

These Operating Instructions contain guidance in the form of pictographs and keypad diagrams, which should help you in finding the required information:

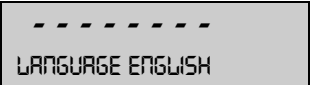
- Key names are presented inside quotation marks and are highlighted in bold font: «**ON/OFF**» or «».
- In order to aid clarity in the explanation of the operating steps, the display for each step is shown graphically on the left alongside the list of operating steps:

Display	Key	Step
		<i>Press repeatedly, until the language currently activated is displayed.</i>

1.2 Warranty card

A warranty card, which was filled in by your Precisa dealer before you received the moisture analyser, is enclosed with the Operating Instructions.

 NOTE
Check that the warranty card is inside these Operating Instructions and that it has been duly completed.

2 Safety

2.1 Representations and symbols

Important safety-related instructions are highlighted visually at the description of what to do:

 DANGER
Warning of a possible danger which may lead to death or to serious injury.

 CAUTION
Warning of a possible danger which may lead to minor injury or damage.

 NOTE
Tips and important rules on how to use the moisture analyser correctly.

2.2 Safety instructions

- When using the instrument in surroundings with increased safety requirements, pay careful attention to the appropriate regulations.
- Only use an extension cord with a protective earth conductor.
- If the mains cord is damaged, disconnect the instrument from the electrical supply immediately and replace the mains cord.
- If there is any reason to believe that it is no longer possible to operate the moisture analyser safely, unplug the instrument immediately from the electrical supply and secure it so that it cannot be operated inadvertently.
- When carrying out maintenance work, it is essential to heed the tips in see chapter 8.1 "Maintenance and servicing".
- The Operating Instructions must be read by everyone who has to operate the instrument and must be kept handy on-site at all times.



DANGER

Do not place any flammable materials on, under or beside the instrument.

Leave enough clear space around the instrument to prevent a build-up of heat.

The moisture analyser may not be used to analyze explosive, highly flammable samples.

Do not operate the moisture analyser in areas where there is any risk of explosion.

Sample materials which release toxic substances must be dried in a fume hood. Take care not to inhale any harmful vapors.

Ensure that no liquid seeps inside the instrument or into the connection ports on the back of the instrument.

If you spill any liquid onto the instrument, unplug it from the electrical supply immediately.

Do not operate the moisture analyser again until you have had it checked by a Precisa service engineer.



CAUTION

Some of the parts, like the heating element and the viewing window, may become considerably hotter while it is in operation. Only touch the instrument using the handles provided.

Take care when you remove the sample. The actual sample, the heating unit and sample pans used may still be very hot.

The moisture analyser should generally be used for drying substances containing water. Sample materials which give off aggressive vapors (like acids) may cause corrosion problems to develop on parts of the instrument.

If any damage or injury occurs, liability and responsibility rest with the user.

3 Set up

3.1 Unpacking

The moisture analyser comes in environmentally-friendly packaging, specifically developed for this precision instrument, which provides optimum protection for the instrument during transportation.



NOTE

Retain the original packaging in order to avoid the moisture analyser becoming damaged in transit when it is shipped or transported and to store the device under optimum conditions if it is out of operation for an extended period.

Follow instructions carefully when you unpack the moisture analyser in order to avoid damaging it:

- Unpack the instrument carefully and gently. This is a precision instrument.
- When temperatures outside are very low, the balance should first be stored for a few hours in the unopened transport package in a dry room at normal room temperature, so that no condensation settles on the balance when it is unpacked.
- Check the moisture analyser for any external visible signs of damage immediately after you unpack it. If you find that it has been damaged in transit, notify your Precisa service agent immediately.
- If the moisture analyser is not being put into operation immediately after purchase, store it in a dry place with minimal fluctuations in temperature (see chapter 3.2.2 "Storage").
- Read these Operating Instructions carefully before operating the balance, even if you have used Precisa equipment before and pay particular attention to the safety instructions (see chapter 2 "Safety").

■ 3 Set up

3.2 Transport, storage

3.2.1 Transport and shipping

Your moisture analyser is a precision instrument. Treat it with care. Avoid shaking it or subjecting it to any heavy jolts or vibrations during transport.

Avoid serious temperature fluctuations and getting the instrument damp (condensation) during transport.



NOTE

The moisture analyser should ideally be shipped and transported in its original packaging to avoid damage in transit.

3.2.2 Storage

If you do not intend to use the instrument for a long time, unplug it from the electrical supply, clean it thoroughly (see chapter 8 "Service") and store it in a place that meets the following conditions:

- No serious shaking or vibrations
- No serious fluctuations in temperature
- No direct exposure to sunlight
- No moisture



NOTE

The moisture analyser should ideally be stored in its original packaging because it gives it optimum protection.

3.3 Inspection and assembly

The moisture analyser does not come fully assembled. Once you have unpacked all the parts, check that the delivery is complete and assemble the individual components in the order indicated below.

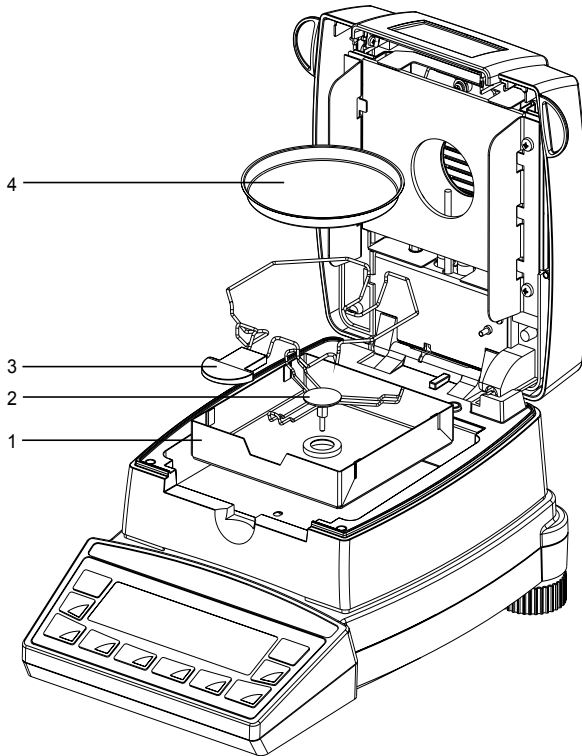

Components delivered	Components delivered
Moisture analyser	In-use cover for the display
Mains cord	30 sample pans (4)
Draftshield (1)	Operating Instructions
Pan support (2)	Warranty card
Sample holder (3)	Declaration of conformity

■ 3 Set up

- Assemble the in-use cover for the display
- Open the hood and insert the draftshield (1), making sure that it is placed on flat.
- Insert the pan support (2) and turn it so that it locks securely in place.
- Insert the sample holder (3) as shown.
- You can now place an aluminium pan (4) on the pan support.



NOTE

All the parts must be attached together without exerting undue force. Do not apply any force. If you have any problems, the Precisa customer service will be happy to help.

3.4 Choosing a suitable location

In order to ensure that the moisture analyser functions properly, select a location that fulfils the following criteria:

- Permissible ambient temperatures
 - Temperature: 5 °C - 40 °C
 - Relative humidity: 25% - 85%, non-condensing
- Put the instrument on a rigid, firm horizontal base, preferably exposed to no vibrations
- Make sure that the instrument cannot be shaken or knocked over
- Do not expose it to direct sunlight
- Avoid drafts and excessive temperature fluctuations
- Leave enough clear space around the instrument to prevent a build-up of heat.

Do not expose the instrument to high levels of moisture for long periods of time. Avoid letting condensation form on the instrument. If instruments are cold, let them warm up to room temperature (approx. 20°C) before connecting them to the mains.

Condensation is practically impossible on instruments which are connected to the mains.

3.5 Connecting it to the mains

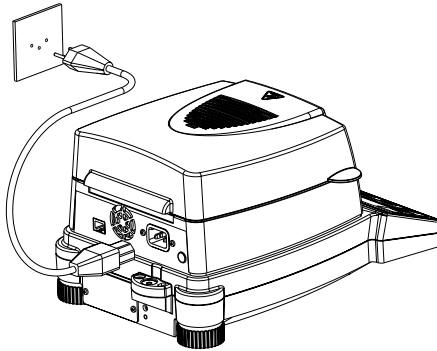

Follow safety instructions when connecting the instrument to the mains:



DANGER

The instrument may only be operated using the original mains cord supplied.

If the mains cord supplied is not long enough, only use an extension cord fitted with a protective earth conductor.

Plug the mains cord into a socket which has been installed in accordance with regulations and is fitted with a PE terminal.

For technical reasons, the heating unit is designed in the factory to accommodate a voltage of 230 V or 115 V and in accordance with your order. Check that the setting matches the local setting?

■ 3 Set up

3.6 Safety measures

The safety class 1 instrument, the moisture analyser, may only be plugged into a socket which has been installed in accordance with regulations and is fitted with a protective earth terminal. The safety effect may not be undone by using an extension lead without an earth wire. If the voltage is coming from mains supplies without a protective earth terminal, arrange for an electrician to create a comparable level of protection in accordance with valid installation regulations.

3.7 Levelling

In order to function properly, the moisture analyser must be precisely horizontal.

The instrument is fitted with a "levelling bubble" and two rotatable feet for level-control, with the aid of which it is possible to compensate for small height differences and/or unevennesses in the surface on which the instrument is standing.

The two screw feet must be adjusted so that the air bubble is precisely in the center of the sight glass of the levelling bubble.

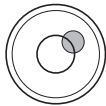

Incorrect

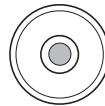

Correct



NOTE

The instrument must be carefully relevelled each time it is moved in order to obtain accurate measurements.

3.8 Weight calibration

Since the Earth's gravity is not the same everywhere, each balance must be adjusted to compensate for the gravity at each location, in accordance with the underlying physical weighing principle. This adjustment process, which is known as "calibration", must be carried out on initial installation and then each time the instrument is moved to another location. However, in order to get exact measurements, the instrument should also be recalibrated periodically.



NOTE

The moisture analyser must be calibrated when it is initially installed and then each time it is moved to another location.

If you work in accordance with "Good Laboratory Practice GLP", observe the prescribed intervals between calibrations (adjustments).

The calibration is set in the configuration menu (see chapter 4.3.6 "Balance calibration").

With the aid of the "Intelligent Calibration Mode" (ICM), the instrument can determine the size of the calibration weight itself, facilitating exact calibration with different size weights (in 10 g increments) (see chapter 8.3.1 "Calibrating the balance").

■ 3 Set up

3.9 First measurement

Once the moisture analyser is successfully up and running, you can perform an initial measurement to familiarize yourself with the new instrument and to test it for any malfunctions.

Switch the instrument on using the «ON/OFF» key. The instrument performs a self-diagnostics test to check the main functions. After completion of the start-up process (which takes about ten seconds), "Zero" appears in the display; this means that the instrument is now ready for operation.

During the first measurement, the instrument uses the drying parameters set in the factory.

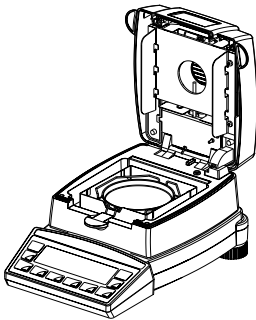

- Open the hood of the instrument
- Place the sample holder with an empty weighing pan onto the weighing pan holder.
Note: The weighing pan must sit flat on the weighing pan holder. Always work with the sample holder; it allows you to work safely and prevents possible burning ones self.



- Press the «T» key.
The instrument is ready to weigh the sample.
- Pour approx. 1.0 g of water into the weighing pan.

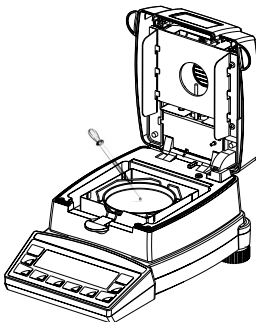

- Close the hood

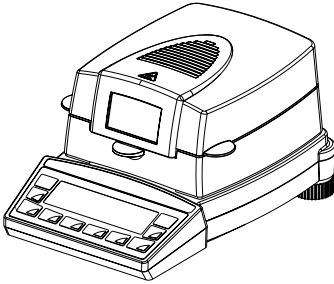

The instrument is prepared for the first measurement.



- Start the measurement by pressing the «**START/STOP**» key.

The heating element heats up to 105°C, and the fan starts to cool.

The moisture analyser display is divided into

the measurement display and

the info line

+	100.00 %	
STD	---°C	0.1MIN

+	93.27 %	
STD	105°C	2.3MIN

- The result appears in the measurement display in the unit of measurement set.
- The info line displays the heating mode used (standard), the current temperature (105°C) and the current duration of the measurement (2.3 min.).
If the temperature is under 40°C, three dashes are displayed: "---°C".

■ 3 Set up

- Once the drying has ended, an audio signal sounds, and the heating is switched off.

The fan keeps running until the temperature in the sample room drops below 40 °C.

+ XX.XX %
DURATION XXX MIN

- The measurement display shows the result in the unit of measurement set. The measurement result is displayed in the other units of measurement by pressing the «» key.
- The info line shows how long the measurement takes.
- Open the hood
- Carefully remove the weighing pan, only gripping the sample holder by the handle.

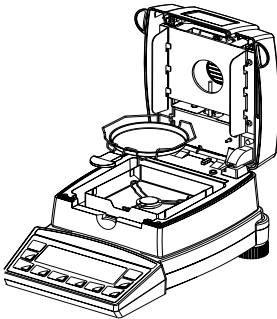

Caution! All the parts of the sample chamber are hot.

Allow the weighing pan and holder to cool down before doing anything else with them.

- Insert a new weighing pan into the instrument.
- Press the «T» key; the instrument is ready for you to perform a new measurement.



CAUTION

The weighing pan and holder are hot!

4 Operation

The moisture analyser has two main menus: the configuration menu and the application menu.

Instrument-specific parameters and the layout of the report printout are defined in the **configuration menu**. You can either work with the basic configuration programmed in the factory or define and save a user configuration which is adapted to suit your specific needs.

Moisture Analyser-specific parameters can be set in the **application menu**. The weighing help is also activated and defined in this menu.

4.1 Menu control operation principle

The configuration menu and the application menu each have a main path and up to two sub-paths in which the parameters for the different functions of the instrument are defined.

Use the cursor keys «←», «→», «↑» and «↓» to move within the paths.

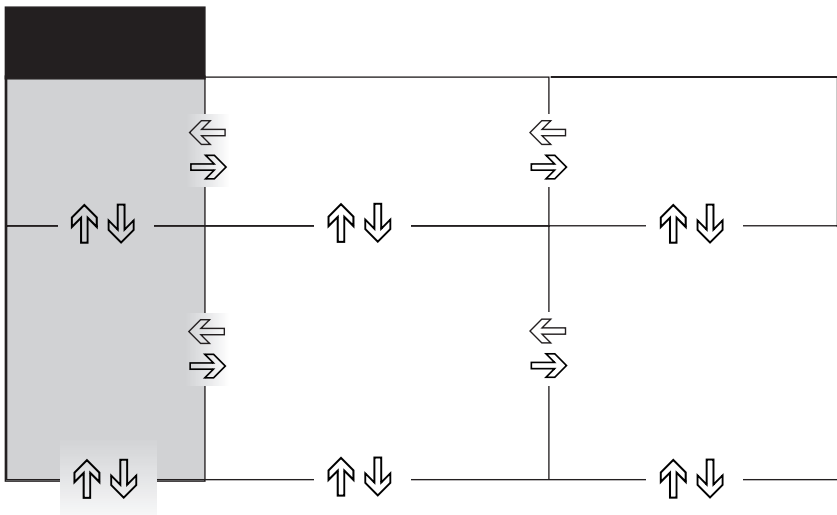





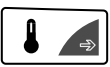

NOTE

The geometry of the menu tree diagram corresponds to the path configurations of the two main menus.

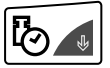
■ 4 Operation

In **program operation mode**, the **key symbols highlighted in blue** apply on the control panel.

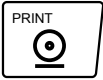
Key(s)	Designation	Function in weighing mode
 	«←», «→»	<ul style="list-style-type: none"> Changes from the main menu path to the sub-paths and vice versa.
 	«↑», «↓»	<ul style="list-style-type: none"> Moving up/down within the main path or sub-paths. Changing selected parameters
	«↵»	<ul style="list-style-type: none"> Selecting parameters Saving the changed parameters
	«esc»	<ul style="list-style-type: none"> Cancelling an entry Exiting the menu
	«ins»	<ul style="list-style-type: none"> Setting a space (in text entries)
	«clr»	<ul style="list-style-type: none"> Clearing an entry (in text entries)
	«PRINT»	<ul style="list-style-type: none"> Entering a decimal point (in text entries)

The instrument can also be operated by remote control. For details of the remote control commands, see chapter 7.2 "Remote control commands".

4.2 Setting and saving the configuration

- Press «**ON/OFF**» to switch the instrument on.
- During the start-up process, keep the «**T**» and «**MENU**» keys pressed in until the configuration you require appears in the display, then let the keys go:
 - "FACTORY CONFIG.": Load the factory configuration.
 - "USER CONFIG.": Load the user configuration.

"STORE CONFIG": Save the current configuration as the user configuration.

4.3 Instrument configuration

This section explains the structure of the configuration menu and its functions.

Main path	Definable functions
SET DATA PRINT	<i>Print formats; type of values to print</i>
SET APP. MENU	<i>Defining the application menu</i>
SET ASH RESIDUE	<i>Defining the ash residue (only for XM66)</i>
SET BALANCE CAL.	<i>Balance calibration method</i>
TEMP. CAL	<i>Activate the temperature calibration</i>
STABILITY	<i>Instability of the balance location</i>
QUICK-START	<i>Setting the start condition</i>
SET INTERFACE	<i>Baud rate, parity, handshake functions of periphery interface</i>
SET DATE AND TIME	<i>Date and time (standard format or American format p.m. and a.m.)</i>
PASSWORD	<i>Password protection for the menu definitions</i>
THEFTCODE	<i>Activation/deactivation and change to the anti-theft code</i>
KEY TONE	<i>Activation of the keypad sound</i>
CONTRAST	<i>Screen contrast (only in instruments with an LCD display)</i>
LANGUAGE	<i>Language (E, D, F)</i>

Representation conventions:

- The settings programmed in the factory are depicted in **bold**.
- In order to aid clarity, the only part of the menu tree shown in each function description is the part which relates to the function in question.

Explanations on the menu functions are depicted in *italics*.

■ 4 Operation



4.3.1 Activating the configuration menu

- Press «ON/OFF» to switch the device on.
- Keep the «MENU» key pressed in continuously during the start-up process (which takes about ten seconds) until "SET DATA PRINT" appears in the display.
- You can now change the configuration menu.

4.3.2 Language function

• LANGUAGE	
SPRACHE DEUTSCH	<i>Selecting a language</i>
LANGUAGE ENGLISH	
LANGUE FRANÇAISE	

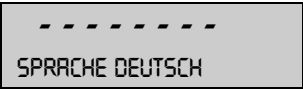
Procedure for changing the language:

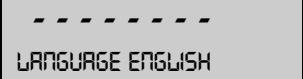
Display	Key	Step
	«↓»	<i>Press repeatedly, until the language currently activated is displayed.</i>
	«←»	<i>The language now flashes.</i>
	«↓»	<i>Press repeatedly until the language you require appears.</i>
	«←»	<i>To confirm the choice of language.</i>

4.3.3 Configuring the report printout

The report printout can be configured in the "SET DATA PRINT" menu option. The options marked "ON" are contained in the report and are printed.

The "MODE PC" function allows the measurement printout to be output in a format which the PC can support. This format only affects the print rate printout and is used for the graphical evaluation of the drying process with the aid of a computer program (such as Excel).

The individual measurements are output separated by tabs, allowing them to be imported easily into a table.

• SET DATA PRINT			
	SET PRINTFORMAT	DATE AND TIME	ON/OFF
		BALANCE-ID	ON/OFF
		METHOD-ID	ON/OFF
		COUNTER	ON/OFF
		DRYER SETUP	ON/OFF
		PRINT RATE	ON/OFF
		OPERATOR-ID	ON/OFF
	PRINT RATE	1.0 MIN	
	OPERATOR	ttt...	
MODE	PRINTER	<i>Printout in text format (40 characters)</i>	
	PC	<i>Print rate printout in a format supported by the PC. The individual measurements are separated by a tab.</i>	

The elements set in "SET PRINTFORMAT" are printed out.

- The interval at which interim results are printed is set at "PRINT RATE". The print interval can be set in 0.1 min increments from 0.1 ... 10.0 min.
- An alphanumerical ID can be entered for the operator at "OPERATOR ttt...".

When a peripheral instrument (e.g. a printer) is connected, the instrument interface must be configured in the "SET INTERFACE" submenu (see chapter 4.3.10 "Interface functions").

■ 4 Operation

Example of a report printout with all the available selection options.

***** PRECISA XM 60 ***** -----	<i>Report title, only output in printer mode.</i>
Date 07.10.2002 Time 11:06:01	<i>Date and time, if this is switched on.</i>
Name : XM 60 Software : N50-0000 P00 Serialno : 3300-1	<i>Balance ID, if this is switched on</i>
Method : Boost/100C	<i>Method ID, if this is switched on</i>
Number : 1	<i>Measurement series counter, if this is switched on</i>
Heat mode : Boost Temperature : 100 C Stop time : 10.0 Min Autostop : 2/20 D/s Standby temp. : 40 C	<i>Moisture Analyser setup, if this is switched on</i>
Original weight : + 2.186 g	<i>Starting weight is always output</i>
Mode Temp Time 100-0% ----- B 105 C 1.0 Min + 86.81 % B 140 C 2.0 Min + 68.08 % B 140 C 3.0 Min + 51.97 % 102 C 4.0 Min + 44.05 % 98 C 5.0 Min + 37.70 % 100 C 6.0 Min + 29.84 % 100 C 7.0 Min + 24.38 % 100 C 8.0 Min + 22.64 % END 100 C 8.2 Min + 22.60 %	<i>The measurement is printed in the unit set for drying, provided the print rate function is switched on. The individual values are separated by tabs in the "MODE PC".</i>
100-0% : + 22.60 % Residual weight : + 0.494 g Stop : Autostop Duration : 8.2 min	<i>Drying results are always output</i>
Operator : SAMPLE	<i>Operator ID, if this is switched on</i>

4.3.4 Configuring the application menu

• SET APP. MENU	
	EDIT METHOD ON/OFF
	METHOD-ID ON/OFF
	TARGET WEIGHT ON/OFF
	UNIT ON/OFF
	PRINT RATE ON/OFF
	STANDBY TEMP. ON/OFF
	AUTOSTART ON/OFF

The options activated under "SET APP. MENU" are enabled in the application menu and can be changed and set there (see chapter 4.4 "Application menu operation").

4.3.5 Configuring the ash residue program

This option is only available with the XM66 moisture analyser. This model contains a special program for the determination of ash residue.

• SET ASH RESIDUE	
	MODE MANUAL/AUTO
	MEMORY CHOICE ON/OFF

By setting ash residue program, the analyser can record the initial sample weight and define the results display mode (see chapter 6 "Ash residue program").

- If "MEMORY CHOICE" option is set to "ON" , the unit can store four sets of results; if it is set to "OFF" , only one set of results can be stored.
- If "MODE AUTO" is active, after each drying sequence the dry weight will be stored as the initial weight for purposes of ash residue determination.

■ 4 Operation

4.3.6 Balance calibration

• SET BALANCE CAL.		
MODE	OFF	<i>disabled</i>
	EXTERNAL	<i>external</i>
	EXT.-DEF.	<i>external with a freely defined weight (DEF. n.nnn g)</i>
DEF.	0.0000 g	<i>Calibration weight for the EXT. DEF. mode</i>

For details about calibrating the balance, see chapter 3.8 "Weight calibration" and see chapter 8.3.1 "Calibrating the balance".

4.3.7 Temperature calibration

• TEMP. CAL.		
TEMP. CAL.	ON/OFF	<i>Activate the temperature calibration</i>

In order to calibrate the temperature, see chapter 8.3.2 "Calibrating the temperature"

4.3.8 Stability

• STABILITY		
STABILITY	HIGH	<i>Setting the stability controle</i>
	MEDIUM	

4.3.9 Quick-start

• QUICK-START		
QUICK-START	ON/OFF	<i>Setting the start condition</i>

"QUICK-START OFF":

The drying sequence starts as soon as a stable weighing value is reached.

"QUICK-START ON":

The drying sequence starts as soon as the «**START**» key is pressed, or

the lid is closed. This enables more accurate moisture analysis of highly volatile samples.

4.3.10 Interface functions

• SET INTERFACE			
	BAUDRATE	300 600 1200 2400 4800 9600 19200	<i>Select the baud rate</i>
	PARITY	7-EVEN-1STOP 7-ODD-1STOP 7-NO-2STOP 8-NO-1STOP	<i>Select the parity</i>
	HANDSHAKE	NO XON-XOFF HARDWARE	<i>Select the handshake function</i>

The RS232/V24 interface on the instrument is matched to the interface of a peripheral instrument with the aid of the interface functions (see chapter 7 "Data transfer").

4.3.11 Date and time

• SET DATE AND TIME			
	DATE	[DD.MM.YY]	<i>Set date and time</i>
	TIME	[HH.MM.SS]	
	FORMAT	STANDARD/US	



NOTE

If a power failure occurs, the timer keeps running. If this doesn't happen, this indicates that the instrument's backup battery has run out and has to be replaced by Precisa Customer Service.

■ 4 Operation

4.3.12 Password protection

The two main menus and the drying parameters for the device can be protected against unwanted changes by using a freely selectable, four-digit password.

- If the password protection is deactivated, any operator can change the instrument settings.
- If "medium" password protection is activated, the configuration menu is protected against unwanted changes.
- If "high" password protection is activated, the configuration menu, the application menu and the drying parameters are protected.
- The disabled menu options and parameters can only be changed again by deactivating the password protection, i.e. by entering the correct password.



NOTE

The password protection is deactivated in the factory settings.

The **preprogrammed password** set in the factory is: **7 9 1 4**

This password is the same for all Precisa instruments and is always valid, at the same time as a password selected by the operator.

Keep a record of your **own password**.

• PASSWORD

PASSWORD ----	DATA-PROTECTION	OFF	<i>No protection</i>
		MED	<i>The configuration menu is protected</i>
		HIGH	<i>The configuration and application menus, as well as the drying parameters are protected</i>
	NEW PASSWORD	----	<i>Enter a new password</i>

Procedure for activating the password protection:

Display

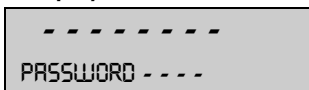

Key



Step

Press repeatedly, until the "PASSWORD" is displayed.

Display	Key	Step
<div style="border: 1px solid black; padding: 5px; text-align: center;"> ----- PASSWORD 0 0 0 0 </div>	«←↓»	The first digit in the password flashes and can be changed.
<div style="border: 1px solid black; padding: 5px; text-align: center;"> ----- PASSWORD 8 0 0 0 </div>	«↑» «↓»	Press repeatedly, until the first digit in the password is set.
<div style="border: 1px solid black; padding: 5px; text-align: center;"> ----- PASSWORD 8 0 0 0 </div>	«⇒»	The second digit flashes. The password can now be entered fully.
<div style="border: 1px solid black; padding: 5px; text-align: center;"> ----- PASSWORD 8000 </div>	«←↓»	Confirm the password.
<div style="border: 1px solid black; padding: 5px; text-align: center;"> ----- DATA-PROTECTION OFF </div>	«⇒»	The data-protection can now be set.
<div style="border: 1px solid black; padding: 5px; text-align: center;"> ----- DATA-PROTECTION OFF </div>	«←↓»	The display flashes, and the data-protection can be activated.
<div style="border: 1px solid black; padding: 5px; text-align: center;"> ----- DATA-PROTECTION HIGH </div>	«↓»	Activate the data-protection.
<div style="border: 1px solid black; padding: 5px; text-align: center;"> ----- DATA-PROTECTION HIGH </div>	«←↓»	Confirm the data-protection.

Procedure for changing the password:

Display	Key	Step
<div style="border: 1px solid black; padding: 5px; text-align: center;"> ----- NEW PASSWORD 7 9 1 4 </div>	«↓»	Press repeatedly, until "NEW CODE" appears. Set the new code as described above.

■ 4 Operation

4.3.13 Anti-theft encoding

The instrument can be protected against theft by using a freely selectable, four-digit numerical code:

- If the anti-theft code is deactivated, the instrument can be switched on again and operated after a power cutoff without having to enter a code.
- If the anti-theft code is activated, the instrument asks for the code to be input after each power cutoff.
- If the code is entered incorrectly, the instrument is blocked.
- If the instrument is blocked, it must first be disconnected from the power supply, then reconnected and unblocked by entering the correct code.
- After seven consecutive incorrect entries, the display reads "NO ACCESS, CALL SERVICE". In this case only a Precisa service engineer can unblock the instrument again.



NOTE

The anti-theft encoding is deactivated in the factory settings.

The **preprogrammed code** set in the factory is: **8 9 3 7**

This code is the same in all Precisa instruments. Therefore, for security reasons enter your own code.

Keep your **own code** in a safe place.

• THEFTCODE

THEFTCODE ----	THEFT-PROTECTIONON/OFF	<i>Switch encoding on/off</i>
	NEW CODE ----	<i>Enter a new code</i>

In order to activate the anti-theft encoding, follow the same steps described for password protection.

4.3.14 Key tone

• KEY TONE

KEY TONE	ON/OFF	<i>Switch key tone on and off</i>
----------	--------	-----------------------------------

If the key tone is switched on, a short audio signal is sounded each time a key is pressed.

4.3.15 Contrast

• CONTRAST

CONTRAST	6	<i>Set the contrast, only in LCD displays</i>
----------	---	---

The display contrast can only be set in instruments with an LCD display; the menu option is not available in instruments with a vacuum fluorescent display.

■ 4 Operation

4.4 Application menu operation

This section explains the structure of the application menu and its functions.

The structure of the application menu is dynamic and can be defined in the configuration menu (see chapter 4.3.4 "Configuring the application menu").

If a menu option is disabled in the configuration menu, it is not contained in the current application menu.

- The menu option "RECALL METHOD" cannot be switched on/off, it is ever present in the application menu.

Main path	Definable functions
RECALL METHOD	<i>Load a saved method</i>
STORE METHOD	<i>Save a method</i>
CLEAR METHOD	<i>Delete a saved method</i>
METHOD	<i>Enter the name of a method</i>
SET TARGET WEIGHT	<i>Definition of starting weight help</i>
UNIT	<i>Selection of the drying unit</i>
PRINT RATE	<i>Enter the interval time for the print rate Only if "PRINT RATE" is also set in printformat</i>
STANDBY TEMP.	<i>Definition of the standby temperature function</i>
AUTOSTART	<i>Definition of the autostart function</i>

Representation conventions:

- The settings programmed in the factory are depicted in **bold**.
- In order to aid clarity, the only part of the menu tree shown in each function description is the part which relates to the application in question.

Explanations on the menu functions are depicted in *italics*.

4.4.1 Activating the application menu

- Press «**MENU**» following the start-up process in order to get to the application menu.

4.4.2 Methods

The XM 60 and XM 60-HR supports the saving of 20 different methods. One method comprises the settings for the drying program and the starting weight.

The XM66 moisture analyser features two freely definable methods, as per the XM 60 or XM 60-HR, and three additional fixed methods (cannot be changed), which have been specially created for the moisture determination of sewage sludge.

Method	105	150/105	220/150/105
Interval 1			
• Temperature	105°C	150°C	220°C
• Stopmode	10d/60s	20%	30%
Interval 2			
• Temperature		105°C	150°C
• Stopmode		10d/60s	10%
Interval 3			
• Temperature			105°C
• Stopmode			10d/60s

The following data is saved for each method:

- Name of the method
- Drying program with:
 - Drying mode
 - Drying temperature
 - Stop time
 - Autostop
 - Autostart setting
 - Standby temperature
 - Unit for the result
- Starting weight with:
 - Nominal weight
 - Upper weight limit
 - Lower weight limit

If the moisture analyser is in weighing mode and the current starting weight is lower than the minimum sample weight (< 0.2 g), the name

■ 4 Operation

of the method currently loaded is displayed in the info line.

If the entry "EDIT METHOD" is switched off in the configuration menu under "Set application menu" (see chapter 4.3.4 "Configuring the application menu"), the menu options "STORE METHOD" and "CLEAR METHOD" are no longer active. Consequently, the methods saved are protected against changes or can only be processed with existing saved methods.

All the current methods and their settings can be printed by keeping the "PRINT" key pressed in until "PRINT APPLICATIONS" appears (see chapter 4.5.2 "The print key").



4.4.2.1 Saving a method

• STORE METHOD	
STORE METHOD	<i>Save a method</i>



Procedure for saving a method:

Set the drying parameters and the starting weight for the required method and enter a name for the method.

Activate the application menu by pressing the «MENU» key briefly.

Display	Key	Step
	«↓»	<i>Press repeatedly, until "STORE METH-ODE" appears.</i>
	«↵»	<i>If the method can be saved, you exit the menu automatically, and the moisture analyser switches back to weighing mode.</i>

If the name has already been used for an existing method in the memory the method cannot be saved

	«↑» «↓»	<i>Select "YES" to replace the existing method or "NO" to enter a different name for the new method.</i>
	«↵»	<i>The method is saved and the moisture analyser switches back to weighing mode.</i>

Display	Key	Step
<p style="text-align: center;">or</p> <div style="border: 1px solid black; padding: 5px; margin-bottom: 5px;"> <p style="text-align: center;">-----</p> <p>REPLACE METHOD NO</p> </div>	«⏪»	<i>The name of the method must be changed.</i>
<div style="border: 1px solid black; padding: 5px; margin-bottom: 5px;"> <p style="text-align: center;">-----</p> <p>METHOD TEST</p> </div>		<i>Enter the new name for the method.</i>
<div style="border: 1px solid black; padding: 5px;"> <p style="text-align: center;">-----</p> <p>METHOD TEST</p> </div>	«⏪»	<i>The method is saved and the moisture analyser switches back to weighing mode.</i>

If all memory slots are occupied, you won't be able to save a new method. In other words, you will have to delete one of the old methods first.

4.4.2.2 Loading a method

• RECALL METHOD		
RECALL METHOD	ttt... ttt... ttt... ttt... ttt...	<i>Select a method Only the existing methods are displayed!</i>

Only methods currently saved are displayed in the menu. If no methods are saved, you cannot go to the "RECALL METHOD" menu. If you press the «⏪» key, the selected method is loaded, and the moisture analyser switches back to the weighing mode.

4.4.2.3 Deleting a method

• CLEAR METHOD		
CLEAR METHOD	ttt... ttt... ttt... ttt... ttt...	<i>Select a method Only the existing methods are displayed!</i>

Only methods currently saved are displayed in the menu. If no

■ 4 Operation

methods are saved, you cannot go to the "CLEAR METHOD" menu. If you press the «» key, the selected method is deleted, and the moisture analyser switches back to the weighing mode.



NOTE

A saving sequence can be cancelled at any time by pressing «**esc**».

4.4.2.4 Setting method name

• METHOD

METHOD	ttt...	<i>Enter the name for the method</i>
--------	--------	--------------------------------------

4.4.3 Starting weight

• SET TARGET WEIGHT

	WEIGHT CHECK ON/OFF	<i>Switch check on/off</i>
	NOMINAL 5.000 g	<i>Enter nominal weight</i>
	UPPER LIMIT 6.000 g	<i>Define upper limit</i>
	LOWER LIMIT 4.000 g	<i>Define lower limit</i>

With the aid of the «TARGET WEIGHT», you can weigh the sample exactly to check that it matches a defined reference value plus/minus permissible deviations.

" + ", " - " and "  " are active in the display.

If "  " lights up, this indicates that the measurement lies within the defined tolerances, and the drying process can commence. If the sample weight lies outside the starting weight tolerance, the drying process cannot be activated. In this case the starting weight tolerances are displayed on the screen as an error message.

4.4.4 Units

• UNIT	
UNIT	100-0%
	0-100%
ATRO	100-999%
	0-999%
	G/KG
RESIDUAL WEIGHT	
WEIGHT LOSS	

The unit of the measurement results printed in the report can be selected in the "UNIT" menu option. The defined unit is also used to print out interim values. The unit of measurement for the printout can only be changed before, and not during, a measurement.

The unit selected is also used as the display unit, although it can also be adjusted during and after the measurement (see chapter 4.5.3 "The change key").

The high resolution moisture analyzers XM 60-HR has a ten times higher readability for the weight and also a ten times higher readability for some of the units for the moisture calculation.

Description/calculation of the units

Explanation of the variables used

- MW: Moist weight (weight value at the start of the measurement)
- DW: Dry weight (weight value at the end of the measurement)

Unit	Calculation
Dry mass in percent:	$100 - 0\% = \frac{DW}{MW} \cdot 100\%$
Moisture in percent:	$0 - 100\% = -\frac{MW-DW}{MW} \cdot 100\%$
ATRO dry mass:	$ATRO\ 100 - 999\% = \frac{MW}{DW} \cdot 100\%$
ATRO moisture:	$ATRO\ 0 - 999\% = -\frac{MW - DW}{DW} \cdot 100\%$

■ 4 Operation

Unit	Calculation
Residual weight in g / kg [%]:	$g / kg = \frac{DW}{MW} \cdot 1000$
Residual weight in g:	RESIDUAL WEIGHT = DW
Moisture in g:	WEIGHTLOSS = MW - DW

Explanations for the ATRO units

The ATRO unit is required exclusively in the wood industry.

In practice, wood contains different amounts of water, which can change continuously. The water content affects the combustion performance of the wood and the heat value. The water evaporates during drying. When wood is stored in the open air, it reaches the so-called air-dried status (A.D.) of 15% to 20% water content. The moisture is completely removed from the wood by heating the wood to temperatures over 100°C. This condition is called absolutely dry (abs.dry).

The wood moisture (*ATRO*) is the amount of water contained in the wood, expressed in terms of the percentage of the mass of the water-free wood and is calculated from the difference between the fresh weight (*MW*) and the dry weight (*DW*).

4.4.5 Print rate

• PRINT RATE	
PRINT RATE	1.0 MIN <i>Print rate interval</i>

The interval at which interim results are printed is set at "PRINT RATE". The print interval can be set in 0.1 min increments from 0.1 .. 10.0 min.

4.4.6 Standby temperature

• STANDBY TEMP.	
STANDBY TEMP.	ON/OFF <i>Switch standby temperature on/off</i>

TEMPERATURE	40°C	<i>Temperature value, only if the standby temperature is switched on</i>
-------------	------	--

Adjusts the temperature in the sample chamber to the set temperature, provided the sample chamber is closed. The temperature range available is 30°C ... 100°C. A flashing circle in the display indicates the standby temperature is not reached, yet.

4.4.7 Autostart

• AUTOSTART	
AUTOSTART	ON/OFF

If autostart is switched on, the measurement is started as soon as the sample chamber is closed. This is provided that the moisture analyser is prepared for a new measurement.

4.5 Special operating keys

4.5.1 The tare key

- Ensure that there is no drying taking place, i.e. that the instrument is in weighing mode.
- **Activating taring**
 - Press «T» briefly.
 - A taring procedure is performed.
- **High resolution mode (HR) selection**
(This option is only available on HR models)
 - Ensure that the moisture analyser is in the Weighing mode
 - Hold down «T» until „HR MODE ON“ or „HR MODE OFF“ is displayed
 - Release «T»
 - If „HR MODE OFF“ is selected the moisture analyser is working only in the low resolution mode and therefore the readability is 10 times lower than in the high resolution mode.
- **Activating calibration**
 - Keep «T» pressed until "BALANCE CALIBRATION" is displayed.
 - Release «T».

■ 4 Operation

- The balance carries out a calibration in accordance with the settings in the configuration menu and logs these in the form of a printout (see chapter 4.3.6 "Balance calibration" and see chapter 8.3.1 "Calibrating the balance").
- **Activating a temperature calibration**
 - Keep «T» pressed until "TEMP. CALIBRATION" is displayed.
 - Release «T».
 - The moisture analyser carries out a temperature calibration and logs it in the form of a printout (see chapter 4.3.7 "Temperature calibration" and see chapter 8.3.2 "Calibrating the temperature").
- **Activating a temperature calibration test**
 - Keep «T» pressed until "TEST TEMPERATURE" is displayed.
 - Release «T».
 - The moisture analyser carries out a temperature test
- **To display the temperature using the temperature adjustment set**
 - Hold down the «T» key until "BOX TEMPERATURE" appears.
 - Release the «T» key.
 - The display of the moisture analyser shows the measured temperature from the temperature adjustment set. The temperature display is removed by again pressing the «T» key. This function is only active when the temperature calibration set is connected to the moisture analyser.



NOTE

The calibration functions of the tare key are only active if they are switched on in the configuration menu. The calibration test are always active.

A calibration or a calibration test procedure can be interrupted by pressing «ON/OFF». This applies both to the balance and to the temperature.

4.5.2 The print key

- Ensure that there is no drying taking place, i.e. that the instrument is in weighing mode.
- **Printing out an individual value or a report**
 - Press «PRINT» briefly.

- The drying report is printed out. The report for the last measurement can be printed out at the start of a new drying procedure. Reports printed afterwards do not contain any interim results. It is otherwise identical to the drying report which is printed during the measurement. If no drying has been performed since the instrument was started up, the weight value is printed.
- **Printing out the statistics (only XM 60, XM 60-HR)**
 - Keep «**PRINT**» pressed until "PRINT STATISTICS" is displayed
 - Release «**PRINT**»
 - Statistics are printed.
- **Resetting the counter to 1 (only XM 66)**
 - Keep «**PRINT**» pressed until "RESET COUNTER" is displayed.
 - Release «**PRINT**».
 - The counter is reset to 1.
- **Printing the instrument settings**
 - Keep «**PRINT**» pressed until "PRINT STATUS" is displayed.
 - Release «**PRINT**». The instrument settings are printed.

Status : -----	<i>Status printout for the settings.</i>
Date 07.10.2002 Time 16:12:39 Name : XM 60 Software : N50-0000 P00 Serialno : 3300-1	<i>Instrument identification</i>
Print : Printformat : Date and Time : on Balance-ID : on Method-ID : on Counter : on Dryer Setup : on Print rate : off Operator-ID : off Print rate : 1.0 min Operator : Mode : Printer	<i>Report printout settings</i>
Calibration : Mode : external Defined weight : 0.0000 g	<i>Balance calibration settings</i>
Temp. cal. : off	<i>Temperature calibration settings</i>
Interface : Baudrate : 9600 Parity : 7-even-1stop Handshake : Hardware	<i>Interface settings</i>
Data-protection : off Theft-protection : off	<i>Security settings</i>
Key tone: on	<i>Key settings</i>

■ 4 Operation



• Printing the application settings

- Keep «**PRINT**» pressed until "PRINT APPLICATIONS" is displayed.
- Release «**PRINT**».
- The application settings and all the settings for the methods currently saved are printed.

Applications : -----	<i>Printout of the application settings and methods.</i>
Dryer setup : Heat mode : Standard Temperature : 105 C Timer stop : off Time : 10.0 min Auto stop : 2/20 D/s Free : 1/20 D/s Autostart : off Standby Temp : off Temperature : 40 C Unit : 100-0%	<i>Current drying parameter settings</i>
Targe weight : Weight check : off Nominal : 5.000 g Upper limit : 6.000 g Lower limit : 4.000 g	<i>Current starting weight settings</i>
Method : TEST Soft Dryer setup : Heat mode : Soft Temperature : 100 C Timer stop : on Time : 25.0 min Auto stop : off Free : 1/20 D/s Autostart : off Standby Temp : on Temperature : 40 C Unit : 100-0% Weight check : off Nominal : 6.000 g Upper limit : 7.000 g Lower limit : 5.500 g	<i>Settings for the first method</i>
Ash residue: Mode : manual memory choice : on	<i>Settings for the ash residue (only XM 66)</i>
Method : TEST Boost Dryer setup : Heat mode : Boost Temperature : 140 C Timer stop : off Time : 10.0 min Auto stop : AdaptStop Free : 1/20 D/s Autostart : off Standby Temp : off Temperature : 40 C Unit : 100-0% Weight check : off Nominal : 3.500 g Upper limit : 4.000 g Lower limit : 2.500 g	<i>Settings for the second method (all the methods saved are printed)</i>
etc....	

4.5.3 The change key

- **Changing units**

- If drying has already been performed or is under way, the unit of measurement displayed can be changed using the change key «». Once a drying procedure is ended, the drying result can be displayed in all the available units until the start of a new drying sequence using the change key «».
- Release «» once the unit to which you wish to change is displayed.

4.5.4 The start/stop key

- **Starting drying manually**

- Ensure that there is no drying taking place, i.e. that the instrument is in weighing mode.
- Press «**START/STOP**» briefly.
- The measurement is started.

- **Stopping drying manually**

- Drying is under way.
- Press «**START/STOP**» briefly.
- The measurement is stopped.

- **Statistics Info (only XM 60, XM 60-HR)**

- Keep «**START/STOP**» pressed until "STATISTICS INFO" is displayed.
- Release «**START/STOP**»

- **Reset Statistics (only XM 60, XM 60-HR)**

- Keep «**START/STOP**» pressed until "RESET STATISTICS" is displayed.
- Release «**START/STOP**»

- **Ash residue**

- Ensure that there is no drying taking place, i.e. that the instrument is in weighing mode.
- Keep «**START/STOP**» pressed until "ASH RESIDUE" is displayed
- Release «**START/STOP**».
- The program ash residue is started (see chapter 6 "Ash residue program").

■ 5 *Determining moisture levels*

5 Determining moisture levels

The moisture analyser is used as a quick and reliable means of determining the moisture content in powders and liquids by the thermogravimetric process.

5.1 Fundamental principles

The term moisture does not just relate to water, it also encompasses all substances which evaporate when they are heated. Alongside water, they also include

- fats
- oils
- alcohol
- solvents
- etc...

There are different techniques for determining the moisture of a material.

Thermogravimetry is the technique used in the moisture analyser. In this technique, the sample is weighed before and after heating so as to determine the moisture content from the difference.

The conventional drying oven technique works on the same principle except that, the measurement takes much longer. In the drying oven technique, the sample is heated from the outside inwards by a stream of hot air so as to draw out the moisture.

In the case of the halogen radiation used in the moisture analyser, the radiation mainly penetrates into the sample where it is converted into heat energy, heating the sample from the inside out. A small portion of the halogen radiation is reflected by the sample; this reflection is lower in dark samples than in light samples. The penetration depth of the halogen radiation depends on the permeability of the sample. In the case of low-permeability samples, the halogen radiation only penetrates into the upper layers of the sample, which may lead to incomplete drying, charring or combustion. Consequently, the sample preparation is extremely important.

5.1.1 Adjusting to the existing measuring process

The moisture analyser is frequently used in place of other drying techniques (like the drying oven) because it is easier to operate and offers shorter measuring times. Consequently, the conventional measuring process has to be adapted to the device so that comparable results can be achieved.

- Performing a parallel measurement
 - Lower temperature setting in the moisture analyser than in the drying oven technique
- The result achieved with the moisture analyser does not match the reference
 - Repeat the measurement with a changed temperature setting
 - Vary the switch-off criterion
- Adapting with the calibration curve or factor

5.2 Sample preparation

Prepare one sample at a time for measurement. This prevents the sample exchanging moisture with the ambient surroundings. If a number of samples have to be taken simultaneously, they should be packed in air-tight containers so as to ensure that they do not change while they are in storage.

Distribute the sample **evenly** and **thinly** on the weighing pan in order to achieve reproducible results.

If it is applied unevenly, this causes an inhomogeneous distribution of heat in the sample being dried, resulting in incomplete drying or an extension to the measuring time. If the sample is piled up, it heats up with greater intensity in the upper layers, causing combustion or encrustation to occur. The high layer thickness or possible formation of a crust prevents the moisture from escaping from the sample. This residual moisture means that measurement results achieved this way are not verifiable and reproducible.

■ 5 Determining moisture levels

Solids:



- Distribute powder samples evenly on the weighing pan.
- Make coarse samples smaller using a mortar or grinder. Do not expose the sample to any heat while you are grinding it as this will lead to a loss of moisture.

Liquids:

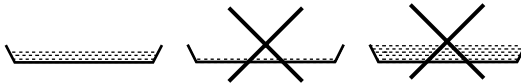

- You are advised to use a fiber glass filter for liquids, pastes or slurry samples. The fiber glass filter offers the following advantages:
 - even distribution on account of the capillary effect
 - no formation of drops
 - quick evaporation due to the larger surface

5.2.1 Preventing samples being encrusted

In order to avoid the sample becoming encrusted, solvent can also be added to the sample after the measurement has started. The solvent added has no bearing on the final result of the measurement.

- Start the measurement, automatically or by pressing the «**START/STOP**» key.
- The moisture analyser hood can be opened again within 5 seconds of the start. During this time, the words "START DRYING" are displayed in the info line of the display.
- After opening the sample chamber, you can add additional solvent at any time until the hood is closed. Once the moisture analyser hood is closed, the measurement is continued. "START COVER CLOSE" appears in the info line in the display. If you press the «**START/STOP**» key, the measurement is interrupted.



NOTE

The additional solvent is taken into account in the measurement printout because all the interim values are calculated on the basis of the current weight value.

However, it has no bearing on the drying result because the solvent has completely dried off.

5.3 Setting drying parameters

The drying parameter setting procedure is started with the four function keys under the display.



Each of the four function keys starts the entry of the corresponding drying parameter. The parameters are entered or changed in the same way as the menu operation procedure (see chapter 4.1 "Menu control operation principle"), except that only the current parameter can be changed each time.

5.3.1 Heating program



This function key is used to start the heating program selection.

There are three heating programs available for determining the moisture content:

- Standard drying
- Boost drying
- Soft drying

■ 5 Determining moisture levels

• HEATING PROGRAM		
BOOST TIME	3.00 MIN	<i>Only XM 60, if Boost is selected</i>
HEAT MODE	STANDARD BOOST SOFT	<i>Select heating program</i>

Standard drying

The drying temperature is predefined by the user. The end temperature is started up with a high heat output and is kept constant with slight overshooting.

This program is used for most samples.

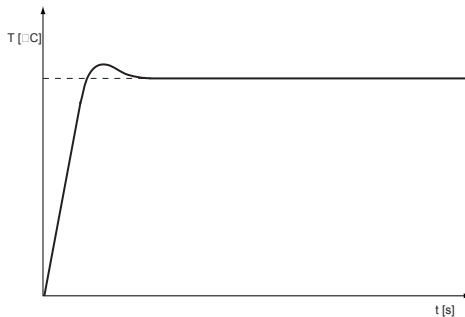

Boost drying

The drying temperature is predefined by the user. During the first three minutes of drying, the target temperature is exceeded by 40%. (In the XM 60, XM 60-HR the time is selectable between 0.1 - 99.9 min) Once this time has elapsed, the temperature is adjusted down to the target temperature. The temperature is started up with a high heat output.

The maximum temperature reached during the boost is 230°C.

5 Determining moisture levels ■

This program is used for samples with a very high moisture content.

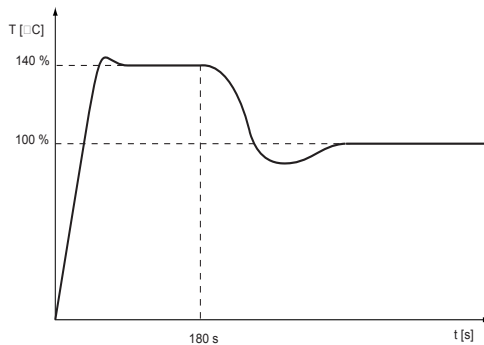

Soft drying

The drying temperature is predefined by the user. The end temperature is started up gently with a low heat output. The end temperature is reached after approx. 4 minutes.

This program is used for samples with a low moisture content in which there is a risk of combustion.

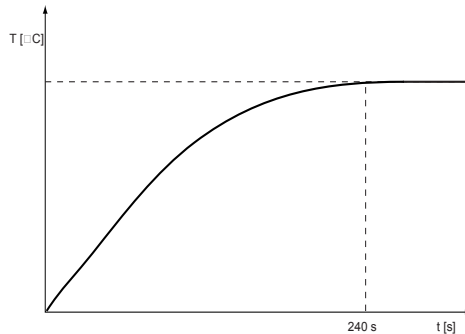

■ 5 Determining moisture levels

5.3.2 Temperature



This function key is used to start the drying temperature input.

The drying temperature can be entered in 1 °C increments from 30 °C ... 230 °C.

After 10 minutes temperatures higher than 200 °C are automatically adjusted down to 200 °C over the course of the next 20 minutes.

• DRYING TEMPERATURE	
TEMPERATURE	105 °C

Temperature input

The temperature setting for drying with moisture analysers is lower than in the case of drying with the drying oven technique.

5.3.3 Timer stop



This function key is used to define the drying time.

If the timer stop is switched on, the measurement procedure is ended once the time set has elapsed.

The time can be set in 0.1 min increments from 0.1 min ... 240.0 min.

• DRYING TIME	
STOP TIME	10.0 MIN
TIMER STOP	ON/OFF

Only if the timer stop is switched on

5.3.4 Switch-off criteria



This function key is used to start the definition of the switch-off criteria for the measurement.

XM 60, XM 60-HR

Two freely definable stop modes are available according to the "digit per time" resp. "% per time" principle. There is also the automatic stop mode "ADAPTSTOP".

• STOPMODE		
DIGIT/TIME	2/20	<i>Only if Digit/Time is selected</i>
%/TIME	0.2/20	<i>Only if %/Time is selected</i>
AUTO STOP	DIGIT/TIME %/TIME ADAPTSTOP OFF	

XM 66

There are five fixed and one freely definable stop modes available according to the "digit per time" principle. There is also the automatic stop mode "ADAPTSTOP".

• STOPMODE		
AUTOSTOP	01/20 D/S	<i>only if FREE is selected</i>
AUTOSTOP	OFF 2/10 2/20 2/30 2/60 10/60 ADAPTSTOP FREE	

■ 5 Determining moisture levels

End-point condition Digit per time

The drying procedure ends as soon as the reduction in weight, during the time set, is smaller than the number of digits set. The reduction in weight must have been greater than the end-point condition at some point.

In the freely definable mode, the user can set from 1 ... 99 digits in 1 digit increments and from 10...90 seconds in 10 second increments.

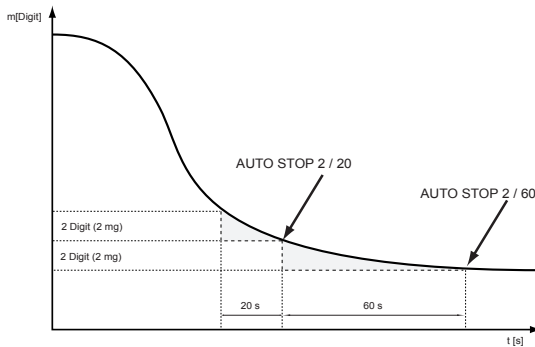

One digit is the smallest change in measurement that can be displayed by the moisture analyser.

In the XM 60, XM 66: 1 digit = 1 mg

In the XM 60-HR: 1 digit = 0.1 mg

End-point condition % per time

The drying procedure ends as soon as the reduction in weight, during the time set, is smaller than the % value set. The moist weight (weight value at the start of the measurement) corresponds to a value of 100%.

Caution: the reduction in weight must have been greater than the end-point condition at some point.

In the freely definable mode, the user can set from 0.1 % ... 99.9 % in 0.1 % increments and from 10...90 seconds in 10 second increments.

ADAPTSTOP

Is a fully automatic stop mode which determines the switch-off time

on the basis of the drying progress.

5.4 Statistics (XM 60, XM 60-HR)

All results are automatically taken into the statistical evaluation.

- Insure that there is no drying taking place, i.e. that the instrument is in weighing mode.
- Keep «**START/STOP**» pressed until "STATISTICS INFO" is displayed
- Release «**START/STOP**»
- Change between the statistical values with «**↓**» resp.«**↑**».

• STATISTICS INFO	
MEAN	<i>Mean</i>
MAX	<i>Maximum</i>
MIN	<i>Minimum</i>
STDDEV	<i>Standard deviation</i>
STDDEV %	<i>Relative standard deviation</i>
1 =	<i>Value 1</i>
2 =	<i>Value 2 etc.</i>

5.4.1 Print statistics

Exit statistics with «**esc**»

- Keep «**PRINT**» pressed until "PRINT STATISTICS" is displayed.
- Release «**PRINT**».

The statistics are printed:

***** Precisa XM 60 ***** -----	<i>Protocol title, printed only in the mode Printer.</i>
Date 07.10.2002 Time 11:06:01	<i>Date and time if set</i>
Name : XM 60 Heater : Halogen / 50Hz Software : N50-0000 P10 Serialno : 3300-001	<i>Balance-ID if set</i>
Method : 105 Date : 28.10.2004 Samples : 4 Unit : 100-0%	
Mean : 57.36 % Maximum : 57.39 % Minimum : 57.34 % Stddev : 0.02 % Stddev % : 0.042 %	<i>Statistics</i>

■ 5 Determining moisture levels

1	: 57.34 %	<i>Recorded values</i>
2	: 57.38 %	
3	: 57.34 %	
4	: 57.39 %	
Last calibr. weight : 13.03.2004		<i>Information on calibration</i>
Last calibr. temp. : 13.03.2004		

5.4.2 Reset statistics

The statistic are reseted by

- restarting the device
- changing the method
- the statistics are manually reseted:
reset statistics
 - Keep «**START/STOP**» pressed until "RESET STATISTICS" is displayed.
 - Release «**START/STOP**».

6 Ash residue program

	<ul style="list-style-type: none"> • Start/Stop-Key 	
	START/STOP DRYING	<i>not displayed</i>
	STATISTICS INFO	<i>only XM 60, XM 60-HR</i>
	RESET STATISTICS	<i>only XM 60, XM 60-HR</i>
	ASH RESIDUE	

The determination method of ash residue varies between the models XM 60, XM 60-HR and XM 66. When determining the ash residue, the desiccated sample is taken as the entry value. This sample is reduced to ash in an external furnace and then re-weighed in the moisture analyser. The ash residue can then be calculated.

Calculation of the ash residue:

Unit	Calculation
Ash residue in percent:	$\text{ash residue} = \frac{\text{residual weight}}{\text{original weight}} \cdot 100\%$

After calculation of the ash residue, a report is printed which is identical for all the XM 60, XM 60-HR and the XM 66.

Report with all selectable options.

<pre>***** Precisa XM 60 ***** -----</pre>	<i>Protocol title, printed only in the mode Printer.</i>
<pre>Date 07.10.2002 Time 11:06:01</pre>	<i>Date and time if set</i>
<pre>Name : XM 60 Heater : Halogen / 50Hz Software : N50-0003 P10 Serialno : 3300-001</pre>	<i>Balance-ID if set</i>
<pre>Ash residue: Original weight : 15.000 g Residual weight : 9.500 g Ash residue : 63.33 %</pre>	<i>Calculation of ash residue</i>
<pre>Operator : MUSTER</pre>	<i>Operator-ID if set</i>

■ 6 Ash residue program

6.1 Ash residue XM 60, XM 60-HR

The XM 60 and XM 60-HR can only store one initial sample weight. There are no options to set parameters for ash residue determination.

Ash residue:

- Ensure that no moisture analysis is taking place, i.e. that the instrument is in weighing mode.

Display	Key	Step
	«START»	<i>Keep the key pressed until "ASH RESIDUE" is displayed. Release the key.</i>

```

+      15.000  9
ORIGINAL  0.000  9
    
```

Pour the sampe into the pan

```

+      15.000  9
ORIGINAL  15.000  9
    
```

«»

The initial weight is stored.

The initial weight is stored until the ash residue calculation has been done. End ash residue mode by pressing «esc».

```

+      0.000  9
RESIDUAL  0.000  9
    
```

or

```

+      0.000  9
ORIGINAL  0.000  9
    
```

«» ,

«»

If an original weight is stored, the residual weight is required when the ash residue is restarted.

(Select original weight or residual weight.)

```

+      9.500  9
RESIDUAL  0.000  9
    
```

Pour the rsedial sample onto the pan

```

+      63.33  %
ASH RESIDUAL
    
```

«»

Save the residual weight and calculate the ash residue.

The ash residue is displayed until any key is pressed to print the ash residue protocol. Than the original and the residual weights are cleared.



NOTE

Tare the moisture analyser with an empty pan before starting the ash residue process.

6.2 Ash residue XM 66

The moisture analyser XM66 can store up to four initial sample weights ("MEMORY CHOICE ON"), which are not deleted after determination of the ash residue. As soon as the moisture analyser is switched off, the stored initial sample weights are deleted.

If "MEMORY CHOICE ON" is selected, up to four tare values and initial sample weights can be stored.

If "MEMORY CHOICE OFF" is selected, only one initial sample weight can be stored. In this case the moisture analyser can only be used after re-weighing is complete, as the tare weight has not been stored.



NOTE

If "MEMORY CHOICE OFF", the moisture analyser cannot be re-zeroed between the initial sample weight and the ash determination.

If the mode "MODE AUTO" is activated, the final dry weight will automatically be stored as the initial sample weight for the ash residue determination. The initial sample weight can also be entered manually.

If the "MODE MANUAL" is activated, the initial sample weight can only be entered by starting the ash residue determination.

If "MEMORY CHOICE ON", together with "MODE MANUAL", the moisture analyser can be used for other moisture determination routines between the initial sample weight and the corresponding re-weighing value (see chapter 4.3.5 "Configuring the ash residue program").

■ 6 Ash residue program

6.2.1 Ash residue of the desiccated samples





To ash the desiccated samples directly without transfer into another crucible, please use "MODE AUTO" (configuration).

The tare value and the dry weight (result of moisture analysis procedure) will be stored and are available for calculation of the ash residue.

The ash residue is calculated using the dry mass.

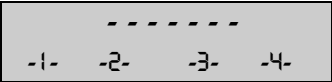
Ash residue:

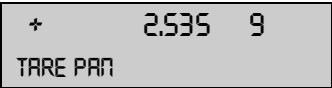
Ensure that no moisture analysis is taking place, i.e. that the instrument is in weighing mode.

Display	Key	Step
	«START»	The weighing numbers 1 .. 4 are displayed.
 <p>----- -1- -2- -3- -4-</p>	«←», «→»	Select the weighing number 1 (resp. 2-4)
 <p>+ 0,000 9 TARE</p>	«T»	Tare the moisture analyser without load
 <p>+ 2,535 9 TARE PAN</p>	«T»	Place the empty pan 1 onto the balance and measure the tara 1.
 <p>+ 7,147 9 PLACE SAMPLE</p>		Place the sample into the pan.
 <p>+ 726,5 9K9 DURATION 3.5 MIN</p>	«esc»	Go back to the weighing mode



Start drying by closing the hood.

The drying result is automatically printed

Repeat these steps for all samples (up to four samples).

Ash the samples externally.

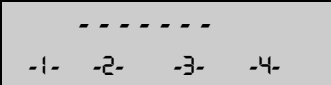
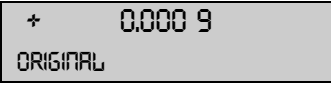
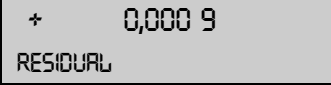
Reweighting the ashed samples:

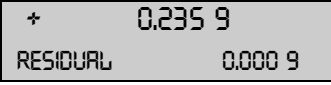
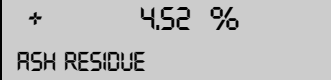
Display	Key	Step
	«START»	Keep the key pressed until "ASH RESIDUE" is displayed. Release the key.
	«←», «→»	Select the weighing number 1 (resp. 2-4:)
	«↓»	Change to residual
	«↵»	Confirm the choice
	«T»	Tare the device without load
		Put the pan with the ash onto the balance
	«↵»	Confirm the weighing



The ash residue is automatically calculated and printed.

If "MEMORY CHOICE OFF", the process will run for only one sample. Selection of the initial sample weight number and re-zero are not necessary.

■ 6 Ash residue program



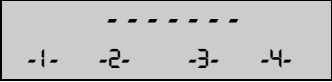

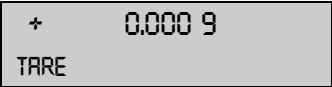
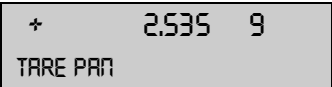
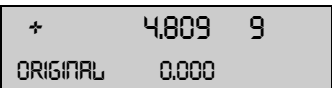
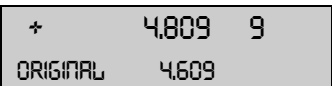
6.2.2 Ash residue with new tare weight

If the dry mass is transferred into a new tare vessel, or if samples are to be used which have not been dried, "MODE MANUAL" or "MODE AUTO" should be used.

Display	Key	Step
	«START»	Keep the key pressed until "ASH RESIDUE" is displayed. Release the key.
	«←», «→»	Select the weighing number1 (resp. 2-4)
	«↵»	Confirm the choice
	«T»	Tare the device without load
	«T»	Place the empty pan1 onto the balance. Measure tara 1.
	«↵»	Pour the sample into the pan. Confirm original weight
		

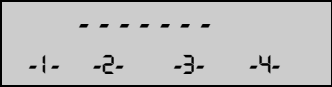
Repeat these steps for all samples (back to the weighing mode with «esc») Ash the samples externally.

Reweighting the ashed samples:

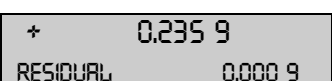
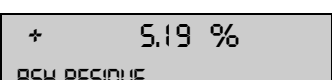
Display	Key	Step
	«START»	Keep the key pressed until "ASH RESIDUE" is displayed. Release the key.
	«←», «→»	Select the weighing number 1 (resp. 2-4)
	«↓»	Change to residual
	«↵»	Confirm choice
	«T»	Tare the device without load
		Put the pan with the ash onto the balance
	«↵»	Confirm weighing

The ash residue is automatically calculated and printed.

If "MEMORY CHOICE OFF", the process will run for only one sample. Selection of the initial sample weight number and re-zero are not necessary.

■ 7 Data transfer

7 Data transfer

The moisture analyser is equipped with an RS232/V24 interface for data transfers to peripheral instruments.

Before the data transfer, the RS232 interface must be matched with the one in the peripheral instrument in the instrument's configuration menu (see chapter 4.3.10 "Interface functions").

- **Handshake**

The handshake is set in the factory to "NO". It can be set to software handshake XON/XOFF or to hardware handshake.

- **Baud rate**

Possible baud rates: 300, 600, 1200, 2400, 4800, 9600 or 19200 baud.

- **Parity**

Possible parity: 7-even-1 stop, 7-odd-1 stop, 7-no-2 stop or 8-no-1 stop.

± 12 V	SB	1	2	3	4	5	6	7	8	SP
7-even-1	SB	1.DA	2.DA	3.DA	4.DA	5.DA	6.DA	7.DA	PB	SP
7-odd-1	SB	1.DA	2.DA	3.DA	4.DA	5.DA	6.DA	7.DA	PB	SP
7-no-2	SB	1.DA	2.DA	3.DA	4.DA	5.DA	6.DA	7.DA	1.SP	2.SP
8-no-1	SB	1.DA	2.DA	3.DA	4.DA	5.DA	6.DA	7.DA	8.DA	SP

SB: Start bit PB: Parity bit
 DA: Data bit SP: Stop bit

- **Display**

S	D7	D6	D5	D4	D3	D2	D1	D0	U	U	U
---	----	----	----	----	----	----	----	----	---	---	---

Data transfer takes place in ASCII code:

1	2	3	4	5	6	7	8	9	10	11	12	13	14	15
B	B	B	S	D7	D6	D5	D4	D3	D2	D1	DP	D0	B	U	...	CR	LF

B Blank (space)
 S Prefix (+, -, space)
 DP Decimal point

D0...D7 Digits

U ... Unit (only if the weight is stable, otherwise no unit is sent)

CR Carriage return

LF Line feed



NOTE

Unused positions are filled with spaces.

The decimal point DP can be between D0 and D7.

7.1 Connection scheme

• Standard duplex connection

moisture analyser	RJ 45	D25 / D9	Peripheral instrument
RS 232 out	2	→ 3 / 2	RS 232 in
RS 232 in	6	← 2 / 3	RS 232 out
GND	5	→ 7 / 5	GND

• Standard duplex connection with additional hardware handshake in the peripheral instrument

moisture analyser	RJ 45	D25 / D9	Peripheral instrument
RS 232 out	2	→ 3 / 2	RS 232 in
RS 232 in	6	← 2 / 3	RS 232 out
GND	5	→ 7 / 5	GND
CTS	3	← 20 / 4	DTR
DTR	7	→ 5 / 8	CTS

■ 7 Data transfer

• Pin configuration of the RJ45 socket

moisture analyser	RJ 45	Remark
n.c.	1	Not connected
RS 232 out	2	Out (V24)
CTS	3	In (V24)
VDC	4	Out (9 ... 16V)
GND	5	0V
RS 232 in	6	In (V24)
DTR	7	Out (V24)
EXTBUS	8	In (5V, logic)

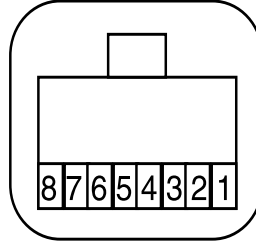

7.2 Remote control commands

Command	Function
ACKn	Acknowledge n=0 off; n= 1 on
CAL	Start calibration (only if EXT is selected)
DN	Reset weight display
D.....	Describe weight display (right-aligned)
@N	Reset info display
@.....	Describe info display
N	Reset instrument
OFF	Switch off instrument
ON	Switch on instrument
PCxxxx	Enter anti-theft code
PDT	Print date and time
PRT	Start printing (Press « PRINT » key)
PST	Start print status
Pn (ttt.t)	Set print mode n = 0 Individually print each value (unstable) n = 1 Individually print a stable value (stable) n = 2 Print after change of load n = 3 Print after each integration period n = 4 Print with time basis in s (ttt.t)

Command	Function
SDTttmmjj hhmmss	Set date and time (German: (Tag, Monat, Jahr, Stunde, Minute, Sekunde))
SDTmmddy hhmmss	Set date and time (Month, Day, Year, Hour, Minutes, Seconds)
T (ttt)	Tare or set tare to a specific value
ZERO	Set instrument to 0 (if weight is stable and within the zero setting range)
Rttt	Adjusts the heating to the required temperature (30 °C ... 230 °C)
ROFF	Switch off heating
PWT (ttt.t)	Print weight value and temperature value Print with time basis in s (ttt.t) (switch off by transmitting PWT)

7.2.1 Examples of the remote control of the instrument

 NOTE
Each remote control command must terminate with «CR» «LF». The commands are acknowledged if required.

Input	Description of the function activated
D - - - - -	Five dashes are displayed
DTEST123	tES123 is displayed
D	The display is dark
T10	-10.000 g (Tare set to = 10 g)
T1	-1.000 g (Tare set to = 1g)
T	Instrument is tared
R100	Adjusts the temperature to 100 °C

8 Service

8.1 Maintenance and servicing

The moisture analyser must be treated carefully and cleaned regularly. This is a precision instrument.



DANGER

To facilitate maintenance work, the instrument must be disconnected from the power supply. Also ensure that the instrument cannot be reconnected to the power supply during the work by anyone else.

Take care during cleaning that no liquid gets into the instrument. If you spill any liquid onto the instrument, unplug it from the electrical supply immediately. Do not operate the moisture analyser again until you have had it checked by a Precisa service engineer.

The connection ports on the back of the instrument may not come into contact with liquids.

Regularly dismantle the weighing pan and the weighing pan holder and remove any dirt or dust from under the weighing pan and on the balance housing with a soft brush or a soft, lint-free cloth, moistened with a mild soap solution.

The balance pan and the holder can be cleaned under running water. Take care to ensure that both parts are completely dry before they are re-installed on the balance.



CAUTION

Never use solvents, acids, alkalis, paint thinners, scouring powders or other aggressive or corrosive chemicals for cleaning since these substances attack the surfaces of the instrument housing and can cause damage.

Regular maintenance of the moisture analyser by your Precisa service

agent will guarantee unrestricted functioning and reliability over many years and will extend the lifespan of the instrument.

8.2 Replacing the mains fuse

If the display remains dark after you switch on the instrument, this generally means that the instrument's fuse is faulty and has to be changed.

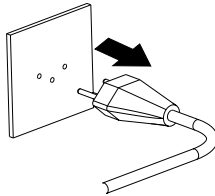

DANGER

Unplug the instrument from the mains before replacing the fuses.

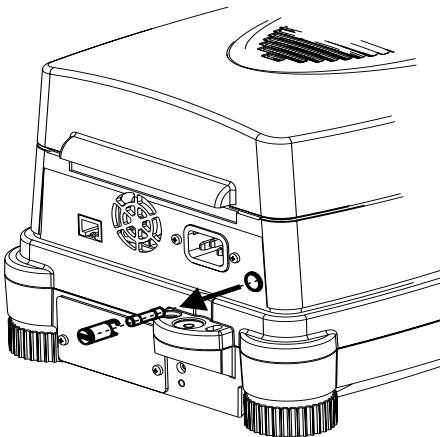

- Screw open the fuse holder on the back of the instrument using a screwdriver, screwing anticlockwise.
- Replace the faulty fuse:
 - 230 volt variant:
T 3.15 A, 230 V, 5x20 mm
 - 115 volt variant:
T 6.3 A, 115 V, 5x20 mm
- If the instrument still does not work after replacing the fuse, contact the Precisa Service Center.



DANGER

Under no circumstances should you use other fuses or attempt to bridge the fuse.

8.3 Calibration

The calibration of the moisture analyser is defined in the configuration menu (see chapter 3.8 "Weight calibration" and see chapter 4.3.6 "Balance calibration").



NOTE

The balance calibration and the temperature calibration can be interrupted at any time by pressing «ON/OFF».

8.3.1 Calibrating the balance

Possible types of balance calibration:

- External calibration by means of ICM (Intelligent Calibration Mode)
- External calibration with a freely definable weight

External calibration by means of ICM

Calibration weights in increments of 10g can be used for the moisture analyser whereby the calibration weights must correspond to the precision of the instrument.

"SET CALIBRATION MODE EXTERNAL" must be set in the configuration menu (see chapter 4.3.6 "Balance calibration") for external calibration by means of ICM.

Display	Key	Step
		<i>The balance is in Weighing mode.</i>
	«T»	<i>Press until "BALANCE CALIBRATION" appears.</i>
		<i>The balance carries out a Zero measurement "0000 g" is shown flashing).</i>
		<i>After the zero measurement the display flashes with the recommended calibration weight.</i>

Display	Key	Step
		Place the calibration weight on the weighing pan. The display continues to flash.
		Calibration is complete when the display stops flashing.

External calibration with a freely definable weight

"SET CALIBRATION MODE EXT.-DEF." must be set in the configuration menu (see chapter 4.3.6 "Balance calibration") for external calibration with a freely definable weight.

You then need to enter the effective value of the calibration weight (DEF. n,nnnn g) with up to ten times the precision of the instrument balance.

	NOTE
Is calibrated with the free weight, so only this weight may be used.	

Procedure to follow:

Display	Key	Step
		The balance is in Weighing mode.
	«T»	Press until "BALANCE CALIBRATION" appears.
		The balance carries out a Zero measurement "0000 g" is shown flashing).
		After the zero measurement the display flashes with the previously entered calibration weight.

■ 8 Service

Display

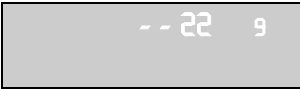

Key

Step

*Place the calibration weight on the weighing pan.
The display continuous to flash.*

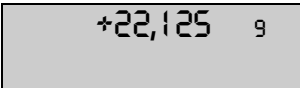

Calibration is complete when the display stops flashing

Calibration report printout

Calibration -----	Balance calibration report
Date 16.10.2002 Time 12:51:36 Name : XM 60 Software : N50-0000 P00 Serialno : 3300-1	Time of the calibration and instrument data
Calibration o.k.	Status of the calibration
Operator :	Operator ID, if activated under Set Print Format (see chapter 4.3.3 "Configuring the report printout").

8.3.2 Calibrating the temperature

In order to enable a temperature calibration to take place, "TEMP. CAL." must be switched on in the configuration menu (see chapter 4.3.7 "Temperature calibration").

The temperature adjustment set must be connected to the moisture analyser via the RS232 interface, and the temperature sensor must be inserted in the sample chamber.

Procedure to follow:

Display



Key

Step

The balance is in Weighing mode.

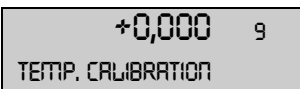

«T»

Press until "TEMP. CALIBRATION" appears.

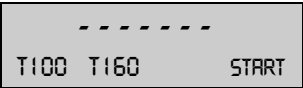
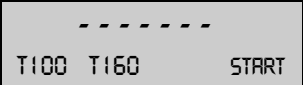
Display	Key	Step
	«←»	Set the lower calibration value.
	«→»	Set the higher calibration value.

Note: The difference between the two temperature-values must be bigger than 40°C.

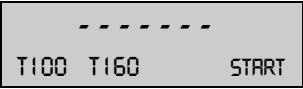
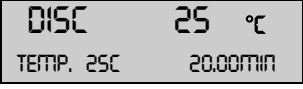
	«START»	Once the temperature adjustment set is connected to the instrument.
		The temperature calibration is started. The moisture analyser heats up to the first temperature.

The temperature and the time remaining for the temperature calibration are displayed in the info line. The measurement display shows the current temperature of the temperature adjustment set.

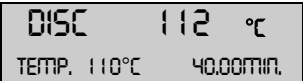
		After 20min., the temperature value is transmitted to the instrument from the temperature adjustment set.
		The moisture analyser heats up to the seconde temperature.

Once the temperature calibration has ended, the report is printed.

■ 8 Service

Temperature calibration report printout

Temperature Calibration -----	Temperature calibration report
Date 16.10.2002 Time 12:51:36 Name : XM 60 Software : N50-0000 P00 Serialno : 3300-1	Time of the calibration and instrument data
Temp. Reference ID : ...	Identifier of the temperature adjustment set
Temperature 100 C : 100 C Temperature 160 C : 160 C	Status of the temperature calibration
Temperature Calibration o.k.	Instrument has been correctly temperature-calibrated
Operator :	Operator ID, if activated under Set Print Format (see chapter 4.3.3 "Configuring the report printout").

8.4 Software update

The moisture analyser is a instrument which is being continuously advanced and improved. For this reason, it is possible to update to the latest version of the instrument software via the internet.

In order to update your software, you need to download the download tool from the Precisa website at www.precisa.com and install it onto a PC (Windows 95 or higher) with a serial interface.

The software for the moisture analyser can also be downloaded from the Downloads area on the Precisa website. This can then be loaded into the instrument with the aid of the download tool.

System requirements

- PC Windows 95 or higher
Serial data cable, depending on the PC's serial interface (see Accessories).

Installation of the download tool

- Download the Download Tool from the Downloads area on the website and install it onto your PC.
- Once the program has been successfully installed, you can start updating the moisture analyser software.

Software download

- Download the software for the moisture analyser from the website under Downloads and save it on your own PC.
- Connect the moisture analyser to the PC via the data cable and switch it on.
- Start the installed Download Tool.
- Select the already downloaded software from your PC and start the download into your moisture analyser.

■ 8 Service

8.5 Error messages

The instrument displays an error description in the info line.

 NOTE
If an error occurs without any corresponding description in the info line, a Precisa service engineer must be called.

Error message	Cause
Starting value too small	<ul style="list-style-type: none">• The sample weight is too small (< 0.200 g). The sample weight must be greater than 0.200 g.
LOWER LIMIT x.xxx g UPPER LIMIT x.xxx g	<ul style="list-style-type: none">• The sample weight does not lie within the tolerance for the starting weight.

8.5.1 Notes on correcting faults

Faults and their possible causes should be listed in the following table. If you cannot clear the fault on the basis of the table, please contact a Precisa service engineer.

Fault	Possible causes
Weight display does not light up	<ul style="list-style-type: none">• Instrument is not switched on• Mains cord is not plugged in• Mains fuse is faulty
"OL" is displayed	<ul style="list-style-type: none">• The weight range has been exceeded (observe the information on the maximum weight range)
"UL" is displayed	<ul style="list-style-type: none">• The weight range is below the range of the instrument (weighing pan or pan holder missing)

Fault	Possible causes
The weight display changes continuously	<ul style="list-style-type: none"> • The draft is too strong at the location of the instrument • The instrument support is vibrating or fluctuating • The weighing pan is touching a foreign body • The sample is absorbing moisture • The sample is evaporating/vaporising/subliming • Sharp changes in temperature in the sample
Results of weighing are clearly incorrect	<ul style="list-style-type: none"> • The instrument has not been correctly tared • The instrument has not been correctly levelled • The calibration is no longer correct • Sharp temperature fluctuations occur
Configuration menu cannot be changed	<ul style="list-style-type: none"> • The password lock is activated in the configuration menu
The display flashes continuously during calibration	<ul style="list-style-type: none"> • The instrument location is not quiet enough (interrupt calibration with «ON/OFF» and move the balance to a better location). • Use of a calibration weight which is too imprecise (only applies to external calibration)
The connected printer won't work	<ul style="list-style-type: none"> • The printer is not switched on • The data cable is faulty or not connected • The interface settings do not match the moisture analyser
The printer prints incorrect characters	<ul style="list-style-type: none"> • The parity setting or the baud rate of the interface don't match • The data cable is faulty
Drying won't start	<ul style="list-style-type: none"> • The sample is not stable

9 Overview

9.1 Technical data

Spezification	XM 60 (-HR)	XM 66
Heat source, heater type	Halogen / Infra-red / Dark Radiator	Halogen / Infra-red / Dark Radiator
Weighing range [g] / Readability [g]	124 / 0.001 (0.0001)	310 / 0.001
Drying:		
Readability [%]	0.01 (0.001)	0.01
Reproducibility in approx. 1g [%]	0.2 (0.1)	0.2
Reproducibility in approx. 10g [%]	0.02 (0.01)	0.02
Sample weight [g]	0.2 - 124	0.2-310
Result calculations:	100-0%, 0-100% ATRO 100-999%, ATRO 0-999%, G/KG, RESIDUAL, LOSS	100-0%, 0-100% ATRO 100-999%, ATRO 0-999%, G/KG, RESIDUAL, LOSS
Heating:		
Temperature range [°C] / Increment [°C]	30 - 230 / 1	30 - 230 / 1
Heating methods	Standard, Boost, Soft	Standard, Boost, Soft
Intervals	Boost + 1	Boost + 1
Booster	+40% during n.n min (0.1 - 99.9)	+40% during 3 min
Switch-off criteria:		
Autostop [d/s]	freely definable 1 - 99 / 10 - 90	5 fixed settings or freely definable 1 - 99 / 10 - 90
Autostop [%/s]	freely definable 0.1 - 99.9 / 10 - 90	-
Adapstop	x	x
Timer stop [min.]	0.1 - 240.0	0.1 - 240.0
Monitoring:		
Viewing window	x	x
Audio	x	x
Printout:		
GLP	x	x
Printout - Interval [min.]	0.1 - 10.0	0.1 - 10.0

Spezification	XM 60 (-HR)	XM 66
Sample numbering	x	x
Memory capacity:		
Methods (with all settings)	20	2 + 3 fixed
User texts	2	2
Operation:		
"Easy access" sample holder	x	x
Display	VFD	VFD
Keypad	10 keys	10 keys
Password protection	x	x
Special features:		
Initial weighing with limits / Initial weighing help	x / x	x / x
Software download and update	x	x
Calibration:		
Balance	with a test weight	with a test weight
Temperature, fully automatic	at 100°C and 160°C	at 100°C and 160°C
Miscellaneous:		
Timer for date and time	x	x
Interface for PCs and printers	RS232	RS232
PrecisaBus	x	x
Digital I/O	optional	optional
Anti-theft protection	Code and mechanically	Code and mechanically
Connection:		
Mains voltage	230V or 115V Can be switched by changing the unit of heat (may only be done by Precisa Service)	230V or 115V Can be switched by changing the unit of heat (may only be done by Precisa Service)
Mains frequency [Hz]	50 - 60	50 - 60
Power consumption [W]	450	450
Dimensions:		
Instrument housing (WxHxD) [mm]	210x170x340	210x170x340
Weight [kg]	6.3	6.3

■ 9 Overview

9.2 Accessories

Accessories	Article number
Interface 20 mA current loop passive	350-8526
Analog output -10 V ... +10 V (10 mV resolution)	350-8508
Input/output module (6 TTL inputs, 8 relay outputs)	350-8509
Multiplexer for up to 7 Precisa instruments (RS232)	350-8513
Data cable RJ 45 - RJ 45, 0.75 m	350-8525
Data cable RJ 45 - RJ 45, 1.5 m	350-8520
Data cable RJ 45 - RJ 45, 3.0 m	350-8521
Data cable RJ 45 - DB9 female (PC), 1.5 m	350-8557
Data cable RJ 45 - DB25 female (PC), 1.5 m	350-8558
Data cable RJ 45 - DB25 male (printer), 1.5 m	350-8559
Dust cover over display, set of 20 pieces	350-8590
Aluminium pans (box of 80)	350-2032
Stainless steel dish, reusable (1 pcs.)	330-2018
Fiber glass filters (box of 80)	350-4130
Printer 230V - with cable and paper roll	350-8363
Printer 130V - with cable and paper roll	350-8370
Roll of paper	350-8366
Ribbon	350-8367
Temperature sensor plate (Sensor - type K)	350-8580
Temperature calibration set (Sensor - type K) with certificate	350-8585
Temperature calibration set (Sensor - type K) without certificate	350-8584
50 g adjustment weight, +/- 0.1mg	350-8241

9.3 Menu

9.3.1 Configuration menu tree

«MENU» Key is pressed during switch-on:

• SET DATA PRINT																												
	<table border="1"> <tr> <td>SET PRINTFORMAT</td> <td>DATE AND TIME</td> <td>ON/OFF</td> </tr> <tr> <td></td> <td>BALANCE-ID</td> <td>ON/OFF</td> </tr> <tr> <td></td> <td>METHOD-ID</td> <td>ON/OFF</td> </tr> <tr> <td></td> <td>COUNTER</td> <td>ON/OFF</td> </tr> <tr> <td></td> <td>DRYER SETUP</td> <td>ON/OFF</td> </tr> <tr> <td></td> <td>PRINT RATE</td> <td>ON/OFF</td> </tr> <tr> <td></td> <td>OPERATOR-ID</td> <td>ON/OFF</td> </tr> <tr> <td></td> <td>PRINT RATE</td> <td>1.0 MIN</td> </tr> <tr> <td></td> <td>OPERATOR</td> <td>ttt...</td> </tr> </table>	SET PRINTFORMAT	DATE AND TIME	ON/OFF		BALANCE-ID	ON/OFF		METHOD-ID	ON/OFF		COUNTER	ON/OFF		DRYER SETUP	ON/OFF		PRINT RATE	ON/OFF		OPERATOR-ID	ON/OFF		PRINT RATE	1.0 MIN		OPERATOR	ttt...
	SET PRINTFORMAT	DATE AND TIME	ON/OFF																									
		BALANCE-ID	ON/OFF																									
		METHOD-ID	ON/OFF																									
	COUNTER	ON/OFF																										
	DRYER SETUP	ON/OFF																										
	PRINT RATE	ON/OFF																										
	OPERATOR-ID	ON/OFF																										
	PRINT RATE	1.0 MIN																										
	OPERATOR	ttt...																										
MODE	PRINTER PC																											
• SET APP. MENU																												
	EDIT METHOD ON/OFF																											
	METHOD-ID ON/OFF																											
	TARGET WEIGHT ON/OFF																											
	UNIT ON/OFF																											
	PRINT RATE ON/OFF																											
	STANDBY TEMP. ON/OFF																											
	AUTOSTART ON/OFF																											
• SET ASH RESIDUE																												
	MODE MANUAL/AUTO																											
	MEMORY CHOICEON/OFF																											
• SET BALANCE CAL.																												
	MODE OFF																											
	MODE EXTERNAL																											
	MODE EXT.-DEF.																											
	DEF. 0.0000 g																											

only XM 66

■ 9 Overview

• TEMP. CAL.	
TEMP. CAL.	ON/OFF
• STABILITY	
STABILITY	MEDIUM HIGH
• QUICK-START	
QUICK-START	ON/OFF
• SET INTERFACE	
	BAUDRATE 300 600 1200 2400 4800 9600 19200
	PARITY 7-EVEN-1STOP 7-ODD-1STOP 7-NO-2STOP 8-NO-1STOP
	HANDSHAKE NO XON-XOFF HARDWARE
• SET DATE AND TIME	
	DATE [DD.MM.YY]
	TIME [HH.MM.SS]
	FORMAT STANDARD/US
• PASSWORD	
PASSWORD ----	DATA-PROTECTION OFF MED HIGH
	NEW PASSWORD - - - -
• THEFTCODE	
THEFTCODE ----	THEFT-PROTECTION ON/OFF
	NEW CODE - - - -

• KEY TONE	
KEY TONE	ON/OFF
• CONTRAST	
CONTRAST	6
• LANGUAGE	
	LANGUAGE ENGLISH
	SPRACHE DEUTSCH
	LANGUE FRANCAISE

9.3.2 Application menu tree

«MENU» Key is pressed during operation:



• RECALL METHOD	
RECALL METHOD	ttt... ttt... ttt... ttt... ttt...
• STORE METHOD	
STORE METHOD	
• CLEAR METHOD	
CLEAR METHOD	ttt... ttt... ttt... ttt... ttt...
• METHOD	
METHOD	ttt...
• SET TARGET WEIGHT	
	WEIGHT CHECK ON/OFF
	NOMINAL 5.000 g
	UPPER LIMIT 6.000 g
	LOWER LIMIT 4.000 g

■ 9 Overview

• UNIT	
UNIT	100-0% 0-100%
	ATRO 100-999%
	ATRO 0-999%
	G/KG
	RESIDUAL WEIGHT
	WEIGHT LOSS
• PRINT RATE	
PRINT RATE	1.0 MIN
• STANDBY TEMP.	
STANDBY TEMP.	ON/OFF
TEMPERATURE	40°C
• AUTOSTART	
AUTOSTART	ON/OFF

9.3.3 Key menus

Hold the appropriate key down until the required menu option appears in the info line.

	• Start/Stop key	
	START/STOP DRYING	<i>not displayed</i>
	STATISTICS INFO	<i>not for XM 66</i>
	RESET STATISTICS	<i>not for XM 66</i>
	ASH RESIDUE	
	• Print key	
	PRINT	<i>not displayed</i>
	RESET COUNTER	<i>only XM 66</i>
	PRINT STATISTICS	<i>not for XM 66</i>
	PRINT STATUS	
PRINT APPLICATIONS		

	• Tare key
	TARE
	HR MODE ON/OFF
	BALANCE CALIBRATION
	TEMP. CALIBRATION
	TEST TEMPERATURE
	BOX TEMPERATURE

not displayed

only if temperature adjustment set is connected

	• Change key
	100-0%
	0-100%
	ATRO 100-999%
	ATRO 0-999%
	G/KG
	RESIDUAL WEIGHT WEIGHT LOSS BALANCE WEIGHT

9.3.4 Setting drying parameters

	• HEATING PROGRAM
	BOOST TIME 3.00 MIN
	HEAT MODE STANDARD BOOST SOFT

not for XM 66

	• DRYING TEMPERATURE
	TEMPERATURE 105°C

	• DRYING Time
	STOP TIME 10.0 MIN
	TIMER STOP ON/OFF

■ 9 Overview

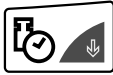
	• STOPMODE	<i>XM 60, XM 60-HR</i>
	DIGIT/TIME	2/20
	%/ZEIT	0.2/20
	AUTO STOP	OFF DIGIT/TIME %/TIME ADAPTSTOP

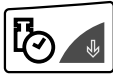
	• STOPMODE	<i>XM 66</i>
	AUTOSTOP	1/20 D/S
	AUTOSTOP	OFF 2/10 2/20 2/30 2/60 ADAPTSTOP FREE

9.3.5 Setting and saving the configuration

«MENU» and «T» keys are pressed during switch-on:

FACTORY CONFIG.	Load the factory configuration
USER CONFIG.	Load the user configuration
STORE CONFIG.	Save the current user configuration

9.4 Index

A

Accessories 80
 ADAPTSTOP 54
 Adjusting to the existing measuring process 47
 Anti-theft code 32
 Application menu 21, 34
 Application menu, activating 34
 Application menu, configuring 27
 Application, printing 44
 Ash residue, configuration 27
 Ash residue, memory choice 27
 Ash residue, mode auto 59
 Ash residue, mode manual 59
 Ash residue, start/stop 45
 ATRO units 40
 Autostart 41

B

Balance calibration 70
 Baud rate 64
 Boost drying 50

C

Calibration 70
 Calibration test, Temperature 42
 Calibration, Balance 17, 41, 70
 Calibration, Temperature 42, 72
 Cleaning 68
 Configuration menu 21
 Configuration menu, activating 24

Configuration, printing 43
 Configuration, save, store, factory 22
 Connection scheme 65
 Contrast 33

D

Data transfer 64
 Date and Time 29
 Drying parameters 49
 Drying, start 45
 Drying, stop 45

E

Encrusting of samples 48
 Error messages 76
 External calibration 70
 External calibration, def. weight 71

F

Factory configuration 22
 Fibre glass filter 48
 Finishing drying 45
 Fundamental principles 46

G

Guarantee 8

H

Handshake 64
 Heating program 49

■ 9 Overview

I

ICM 70

K

Key sound 33

L

LCD display 33

Levelling 16

Location 14

M

Mains connection 15

Maintenance 68

Method, content 35

Method, delete 37

Method, enabling 27

Method, load 37

Method, printing 44

Method, protection 36

Method, save 36

P

Parity 64

Password protection 30

Print key 42

Product counter, reset 43

R

Recall method 34

Remote control commands 66

Replacing the mains fuse 69

Report, printing 42

RJ45 socket 66

S

Safety instructions 9

Safety measures 16

Sample preparation 47

Scope of delivery 13

Service 68

Servicing 68

Socket RJ45 66

Soft drying 51

Software update 75

Standard drying 50

Standby temperature 40

Standby temperature, enabling
27

Starting drying 45

Starting Weight 38

Statistics, Reset 45

Storage 12

Switch-off criteria 53

Switch-off criterion %/time 54

Switch-off criterion digit/time
54

Switch-off, setting 53

T

Tare key 41

Target Weight 38

Target Weight, enabling 27

Taring 41

Technical data 78

Temperature calibration 28, 72

Temperature, setting 52

Time and Date 29

Timer stop, setting 52

Transport 12

Troubleshooting 76

U

Units 39

Units, calculation 39

Units, change 45

Unpacking 11